



[DCA HOME](#) | [ABOUT DCA](#) | [DCA PROGRAMS](#) | [CONTACT DCA](#)

[BCIS Home](#) | [Log In](#) | [User Registration](#) | [Hot Topics](#) | [Submit Surcharge](#) | [Stats & Facts](#) | [Publications](#) | [FBC Staff](#) | [BCIS Site Map](#) | [Links](#) | [Search](#)



Product Approval

USER: Public User

[Product Approval Menu](#) > [Product or Application Search](#) > [Application List](#) > **Application Detail**

- ▶ COMMUNITY PLANNING
- ▶ HOUSING & COMMUNITY DEVELOPMENT
- ▶ EMERGENCY MANAGEMENT
- ▶ OFFICE OF THE SECRETARY

<p>FL #</p> <p>Application Type</p> <p>Code Version</p> <p>Application Status</p> <p>Comments</p> <p>Archived</p> <p>Product Manufacturer</p> <p>Address/Phone/Email</p> <p>Authorized Signature</p> <p>Technical Representative</p> <p>Address/Phone/Email</p> <p>Quality Assurance Representative</p> <p>Address/Phone/Email</p> <p>Category</p> <p>Subcategory</p> <p>Compliance Method</p> <p>Florida Engineer or Architect Name who developed the Evaluation Report</p> <p>Florida License</p> <p>Quality Assurance Entity</p> <p>Quality Assurance Contract Expiration Date</p> <p>Validated By</p> <p>Certificate of Independence</p> <p>Referenced Standard and Year (of Standard)</p> <p>Equivalence of Product Standards Certified By</p>	<p>FL6417-R2</p> <p>Revision</p> <p>2007</p> <p>Approved</p> <p><input type="checkbox"/></p> <p>Transparent Protection Systems, Inc.</p> <p>6643 42nd Terrace North</p> <p>West Palm Beach, FL 33407</p> <p>Frank Bennardo</p> <p>frank@engexp.com</p> <p>Scott D. Kuntz</p> <p>6643 42nd Terrace North</p> <p>West Palm Beach, FL 33407</p> <p>(561) 844-2445</p> <p>scottkuntz@transparentprotection.com</p> <p></p> <p>Shutters</p> <p>Storm Panels</p> <p>Evaluation Report from a Florida Registered Architect or a Licensed Florida Professional Engineer</p> <p><input checked="" type="checkbox"/> Evaluation Report - Hardcopy Received</p> <p>Frank L. Bennardo, P.E.</p> <p>PE-0046549</p> <p>National Accreditation and Management Institute</p> <p>12/31/2012</p> <p>Jorge A. Pomerantz, P.E.</p> <p><input checked="" type="checkbox"/> Validation Checklist - Hardcopy Received</p> <p>FL6417_R2_COI_Cert_Indep.pdf</p> <table border="0"> <thead> <tr> <th style="text-decoration: underline;">Standard</th> <th style="text-decoration: underline;">Year</th> </tr> </thead> <tbody> <tr> <td>ASTM E1886</td> <td>2002</td> </tr> <tr> <td>ASTM E1886</td> <td>2005</td> </tr> <tr> <td>ASTM E1996</td> <td>2002</td> </tr> <tr> <td>ASTM E1996</td> <td>2005</td> </tr> <tr> <td>ASTM E330</td> <td>2002</td> </tr> </tbody> </table>	Standard	Year	ASTM E1886	2002	ASTM E1886	2005	ASTM E1996	2002	ASTM E1996	2005	ASTM E330	2002
Standard	Year												
ASTM E1886	2002												
ASTM E1886	2005												
ASTM E1996	2002												
ASTM E1996	2005												
ASTM E330	2002												

Product Evaluation Report

December 31, 2008

Application Number: FL6417
FLB Project Number: 08-TPS-0008

Product Manufacturer: Transparent Protection Systems, Inc.
Manufacturer Address: 6643 42nd Terrace North
West Palm Beach, FL 33407

Product Name & Description: ClearGuard Polycarbonate Storm Panels (Non-HVHZ)

Scope of Evaluation:

This Product Evaluation Report is being issued in accordance with the requirements of the Florida Department of Community Affairs (Florida Building Commission) Rule Chapter 9B-72.070, F.A.C., for statewide acceptance per Method 1(d). The product noted above has been tested and/or evaluated as summarized herein to show compliance with the 2007 Florida Building Code and is, for the purpose intended, at least equivalent to that required by the Code. Re-evaluation of this product shall be required following pertinent Florida Building Code modifications or revisions.

Substantiating Data:

- **PRODUCT EVALUATION DOCUMENTS**

FLB drawing #08-TPS-0008 titled "ClearGuard Polycarbonate Storm Panels (Non-HVHZ)", sheets 1-5, prepared by Engineering Express, signed & sealed by Frank L. Bennardo, P.E. is an integral part of this Evaluation Report.

- **TEST REPORTS**

Uniform static structural performance has been tested in accordance with ASTM E330-02 test standards per test report(s) #04-009-FE-ASTM & #04-009-LE-ASTM by Construction Testing Corporation (CTC) and test report(s) #0239-0312-06, #0239-0813-06, #0239-0110-07 & #0239-1013-07 by Hurricane Test Laboratory (HTL).

Large missile impact resistance and cyclic loading performance have been tested in accordance with ASTM E1886-02, ASTM E1886-05, ASTM E1996-02 and ASTM E1996-05 test standards per test report(s) #04-009-FE-ASTM & #04-009-LE-ASTM by Construction Testing Corporation (CTC) and per test report(s) #0239-0813-06, #0239-0110-07 & #0239-1013-07 by Hurricane Test Laboratory (HTL).

Self-ignition temperature, Rate of Burning, and Smoke Density have been tested in accordance with ASTM D1929-96, ASTM D635-98, & ASTM D2843-99 standards (respectively) per test report #ETC-01-753-10724.1 by ETC Laboratories (ETC).

UV weathering resistance has been tested in accordance with ASTM G26 (equivalent to ASTM G155-00ae1) and ASTM D638 standards per test report #TPI-001-02-01 by PRI Asphalt Technologies (PRI).

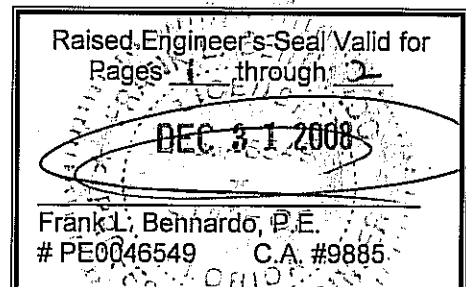

- **STRUCTURAL ENGINEERING CALCULATIONS**

Structural engineering calculations have been prepared which evaluate the product based on comparative and/or rational analysis to qualify the following design criteria:

1. Minimum Glass Separation
2. Anchor Spacing
3. Maximum Allowable Size/Pressure Combinations

No 33% increase in allowable stress has been used in the design of this product.

When installed outside the HVHZ, this system has been designed as a non-porous assembly as defined in the ASTM E1996-02 standard. Therefore, a minimum separation between the shutter and any glazing behind it is NOT required outside the HVHZ.

Impact Resistance:

Large Missile Impact Resistance has been demonstrated as evidenced in previously listed test reports, and is accounted for in the engineering design of this product.

Wind Load Resistance

This product has been designed to resist wind loads as indicated in the span schedule(s) on the Product Evaluation Document (i.e. engineering drawing).

Installation

The product listed above shall be installed in strict compliance with the Product Evaluation Document (i.e. engineering drawing), along with all components noted therein.

The product components shall be of the material specified in the Product Evaluation Document (i.e. engineering drawing).

Limitations & Conditions of Use:

Use of this product shall be in strict accordance with the Product Evaluation Document (i.e. engineering drawing) as noted herein.

All supporting host structures shall be designed to resist all superimposed loads and shall be of a material listed in this product's respective anchor schedule. Host structure conditions which are not accounted for in this product's respective anchor schedule shall be designed for on a site-specific basis by a registered professional engineer.

All components which are permanently installed shall be protected against corrosion, contamination, and other such damage at all times.

This product has NOT been designed for use within the High Velocity Hurricane Zone (HVHZ).

December 31, 2008

Florida Department of Community Affairs
2555 Shumard Oak Boulevard
Tallahassee, FL 32399

Regarding: Transparent Protection Systems, Inc.
ClearGuard Polycarbonate Storm Panels (Non-HVHZ)
Project #08-TPS-0008

To Whom It May Concern:

Please be advised that the below-signed engineer does not have nor will acquire a financial interest in the company manufacturing or distributing the product(s) for which an evaluation report or validation certification has been prepared, as referenced above. This engineer is not owned, operated, nor controlled by the manufacturer or distributor noted above and does not have any financial interest in any other entity involved in the approval process of the above-noted product(s).

Respectfully,

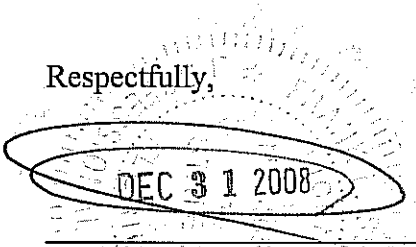
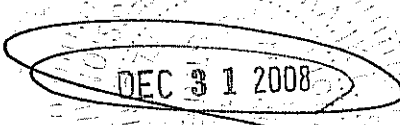

DEC 31 2008

Frank L. Bennardo, P.E.
Frank L. Bennardo, P.E., Inc.
FL PE 0046549
Cert of Auth #9885

GENERAL NOTES:

- THIS SYSTEM HAS BEEN TESTED AND EVALUATED AS A LARGE MISSILE IMPACT PROTECTIVE SYSTEM IN ACCORDANCE WITH THE REQUIREMENTS OF THE 2007 FLORIDA BUILDING CODE AND THE 2006 INTERNATIONAL BUILDING/RESIDENTIAL CODE PER ASTM STANDARDS E330, E1886, & E1996. PANELS ARE APPROVED FOR USE IN FLORIDA OUTSIDE THE HIGH VELOCITY HURRICANE ZONE, OR THROUGHOUT OTHER AREAS GOVERNED BY THE 2006 IBC/IRC.
- TESTING HAS BEEN PERFORMED IN ACCORDANCE WITH THE ASTM E1996 STANDARD FOR USE IN HIGH VELOCITY WIND ZONES (WIND ZONE 4) WHERE THE BASIC WIND SPEED IS GREATER THAN 140 MPH.
- NO 33-1/3% INCREASE IN ALLOWABLE STRESS HAS BEEN USED IN THE DESIGN OF THIS PRODUCT.
- POSITIVE AND NEGATIVE DESIGN PRESSURES TO BE USED WITH THESE DRAWINGS SHALL BE DETERMINED BY OTHERS FOR SPECIFIC JOBS IN ACCORDANCE WITH THE GOVERNING CODE. WHEN CALCULATING PRESSURES PER ASCE 7-05, USE OF DIRECTIONALITY FACTOR $K_d=0.85$ IS ALLOWED.
- THE SYSTEM DETAILED HEREIN IS GENERIC AND DOES NOT PROVIDE INFORMATION FOR A SPECIFIC SITE. IF SITE CONDITIONS DEVIATE FROM THE CONDITIONS DETAILED HEREIN, A LICENSED ENGINEER OR REGISTERED ARCHITECT SHALL PREPARE SITE SPECIFIC DOCUMENTS TO BE USED IN CONJUNCTION WITH THIS DOCUMENT.
- CLEAR POLYCARBONATE STORM PANELS (FULL, HALF, & DOUBLE-WIDE) MAY VARY IN "COVERAGE" WIDTH UP TO THE RESPECTIVE MAXIMA SHOWN HEREIN, PROVIDED THAT THE PANEL PROFILE HEIGHT BE MAINTAINED. PANELS SHALL BE MOUNTED WITH FASTENERS OR STUDS AT MAXIMUM SPACING SHOWN FOR EACH PROFILE.
- ALL POLYCARBONATE PANELS SHALL BE MANUFACTURED BY TRANSPARENT PROTECTION SYSTEMS, Inc.
- THIS PRODUCT APPROVAL IS FOR THE USE OF CLEAR POLYCARB PANELS ONLY. ALL POLYCARB PANELS SHALL BE EXTRUDED WITH THICKNESS $t=0.100"$ ($\pm 0.010"$) AND SHALL BE MANUFACTURED FROM 100% SYNTHETIC THERMOPLASTIC POLYMER RESIN (UV STABILIZED). TYPICAL SYNTHETIC THERMOPLASTIC POLYMER TENSILE STRENGTH $F_y=8.908$ KSI, FLEXURAL STRENGTH $F_{bY}=12.90$ KSI, & FLEXURAL MODULUS IS 328.7 KSI.
- ALL EXTRUSIONS SHALL BE 6063-T6 ALUMINUM ALLOY, U.N.O.
- PANELS SHALL BE PERMANENTLY LABELED WITH A MINIMUM OF ONE LABEL PER PANEL CONTAINING THE FOLLOWING:
TRANSPARENT PROTECTION SYSTEMS, INC.
WEST PALM BEACH, FLORIDA

NOTE: TEST STANDARDS AND PRODUCT APPROVAL NUMBERS SHALL BE INCLUDED IN PANEL LABELS.

- STORM PANELS HAVE BEEN DESIGNED AND TESTED TO THE MAXIMUM SPANS AND CORRESPONDING LOADS SHOWN HEREIN. REFERENCE CONSTRUCTION TESTING CORPORATION (CTC OF MIAMI, FL) TEST REPORTS #04-009-FE-ASTM & #04-009-LE-ASTM, AS WELL AS HURRICANE TEST LAB (HTL OF RIVIERA BEACH, FL) TEST REPORTS #0239-0107-05, #0239-1013-07, #0239-0312-06, #0239-0110-07 & #0239-0813-06.
- TOP & BOTTOM MOUNTING SECTIONS MAY BE INTERCHANGED AS FIELD CONDITIONS DICTATE. PANELS MAY BE MOUNTED VERTICALLY OR HORIZONTALLY AS APPLICABLE.
- USE OF KEYHOLE WASHERS IS OPTIONAL IN CONJUNCTION WITH ANY MOUNTING CONDITION. HOLES MAY BE FIELD DRILLED AT $\varnothing 3/8"$ (OR $\varnothing 5/8"$ WITH KEYHOLE WASHER) WITH ANY FASTENER TYPE. WASHERED WINGNUTS SHALL HAVE 0.865" MINIMUM WASHER DIAMETER.
- ALL BOLTS & WASHERS SHALL BE ZINC COATED STEEL, GALVANIZED STEEL, OR STAINLESS STEEL WITH A MINIMUM TENSILE YIELD STRENGTH OF 60 KSI.

*NOTE: FOR ALTERNATE ARCH TOP INSTALLATIONS, THE TOP TRACK OR U-HEADER SHALL BE CUT INTO 6" MINIMUM ADJACENT SEGMENTS. EACH SEGMENT SHALL HAVE ANCHORS SPACED PER THE ANCHOR SCHEDULE, WITH A MINIMUM OF (2) ANCHORS PER SEGMENT. ANCHORS SHALL BE 1-1/2" MIN FROM ENDS OF EACH SEGMENT AND SPACED 3" MINIMUM FROM ADJACENT ANCHORS. FOR STUDDER TRACKS ONLY, THERE SHALL BE A MINIMUM OF (1) STUD PER SEGMENT FASTENED TO THE STORM PANEL. STUDS SHALL BE LOCATED 2" MINIMUM FROM ENDS OF EACH SEGMENT.

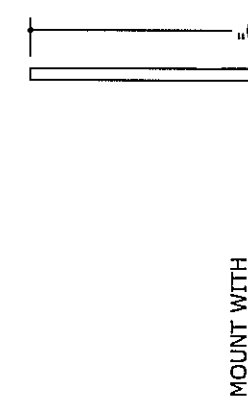

1 FULL PANEL PROFILE
3" = 1'-0"
(SEE GEN NOTE 7)

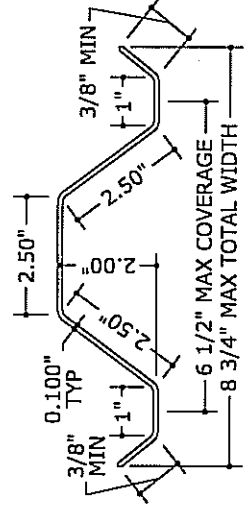

2 HALF PANEL PROFILE
3" = 1'-0"
(SEE GEN NOTE 7)

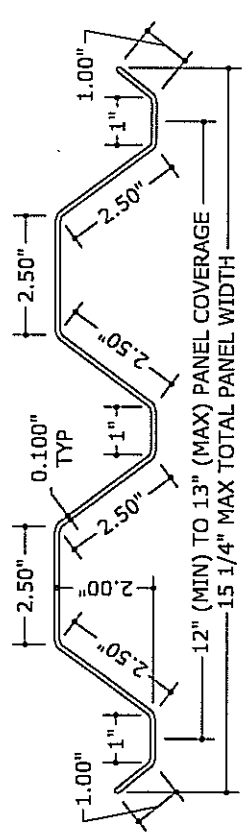

3 STUD ANGLE
6" = 1'-0"

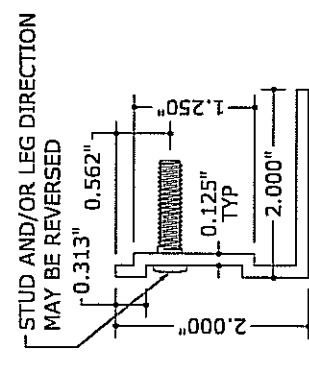

4 REVERSE 'F' ANGLE
6" = 1'-0"

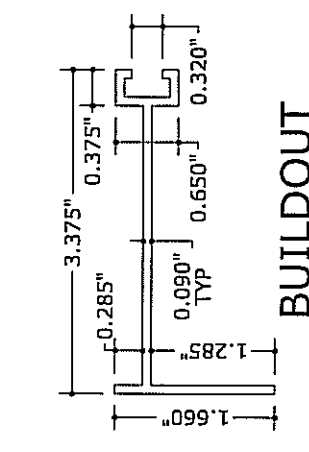

5 BUILDOUT 'F' TRACK
6" = 1'-0"

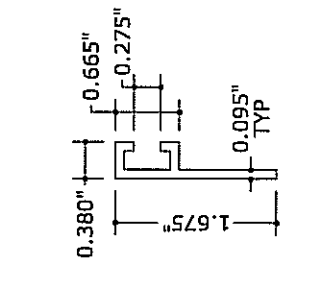

6 'F' TRACK
6" = 1'-0"

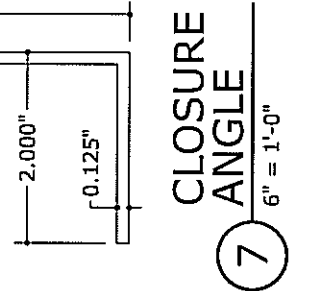

7 CLOSURE ANGLE
6" = 1'-0"

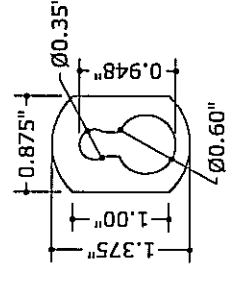

8 KEYHOLE WASHER
6" = 1'-0"

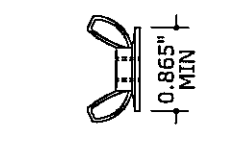

9 WASHERED WINGNUT
6" = 1'-0"

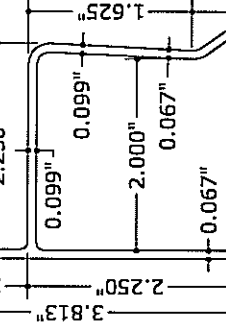

10 'H' HEADER
6" = 1'-0"

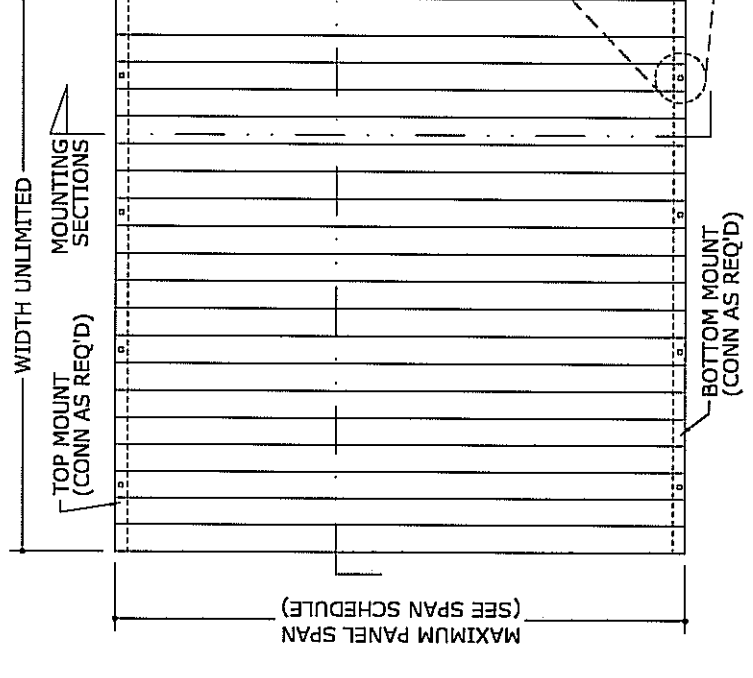

1 TYPICAL ELEVATION
1" = N.T.S.

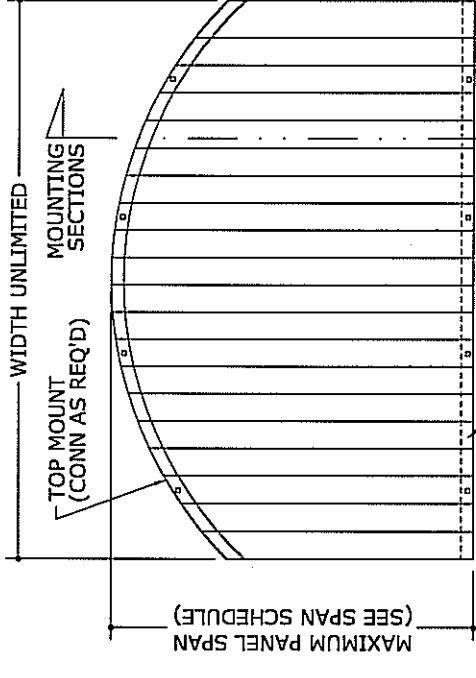

2 KEYHOLE DETAIL
1" = N.T.S.
ALT: FIELD DRILL $\varnothing 3/8"$ HOLE (OR $\varnothing 5/8"$ HOLE W/ KEYHOLE WASHER)

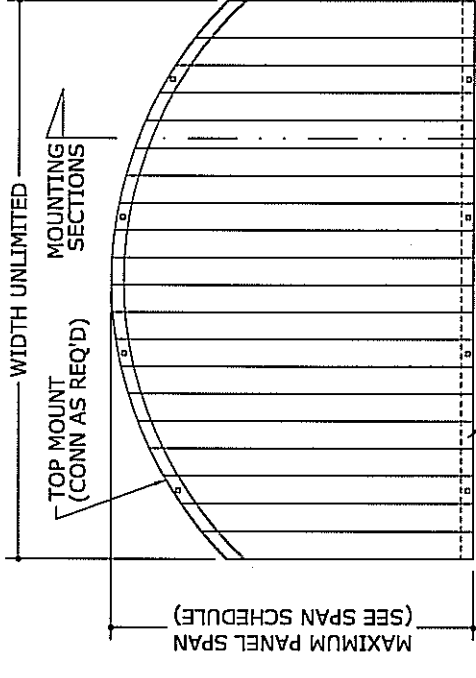

3 ALT. ARCH TOP*
1" = N.T.S.

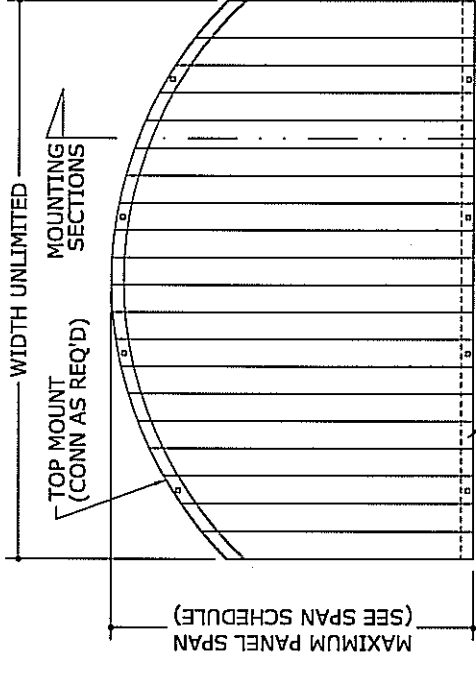

4 PLAN VIEWS

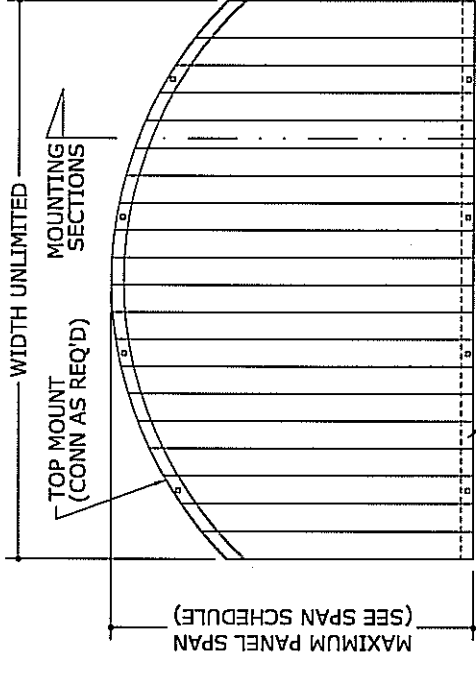

5 MOUNTING SECTIONS

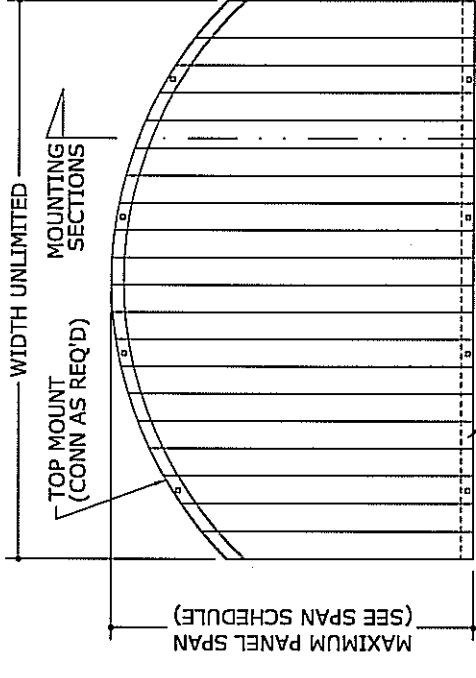

6 BOTTOM MOUNT (CONN AS REQ'D)

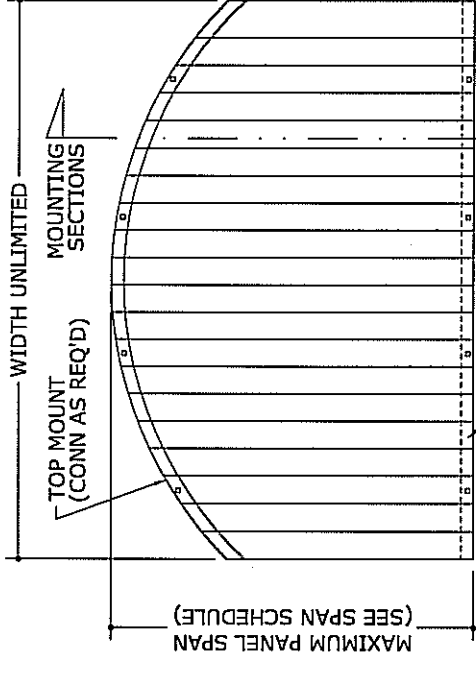

7 TOP MOUNT (CONN AS REQ'D)

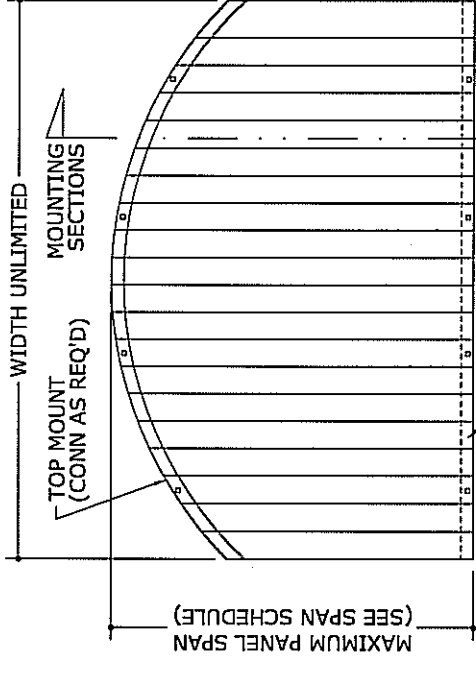

8 WIDTH UNLIMITED

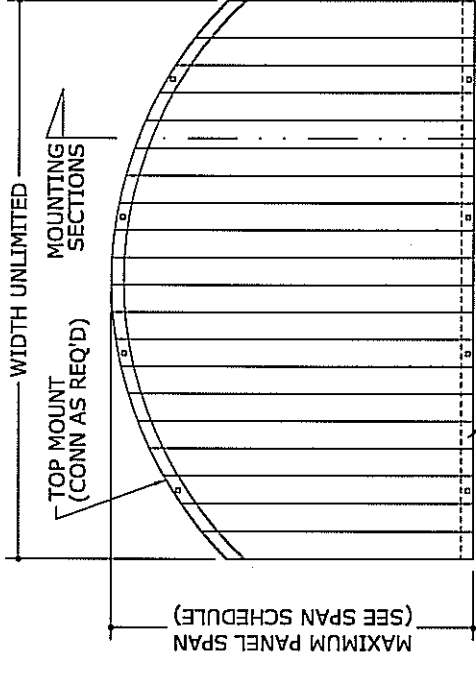

9 MAXIMUM PANEL SPAN (SEE SPAN SCHEDULE)

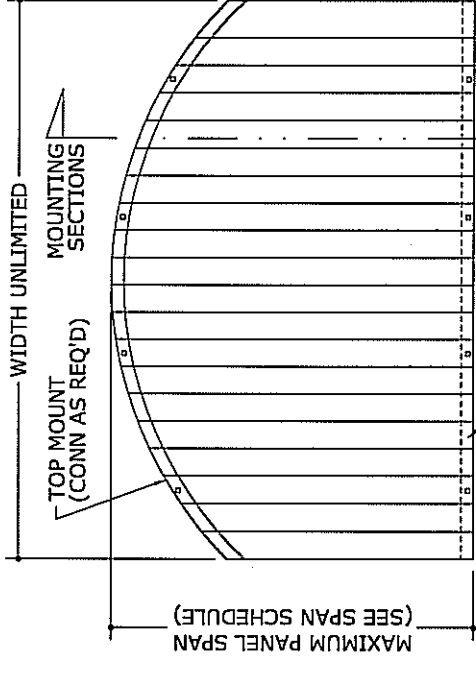

10 BOTTOM MOUNT (CONN AS REQ'D)

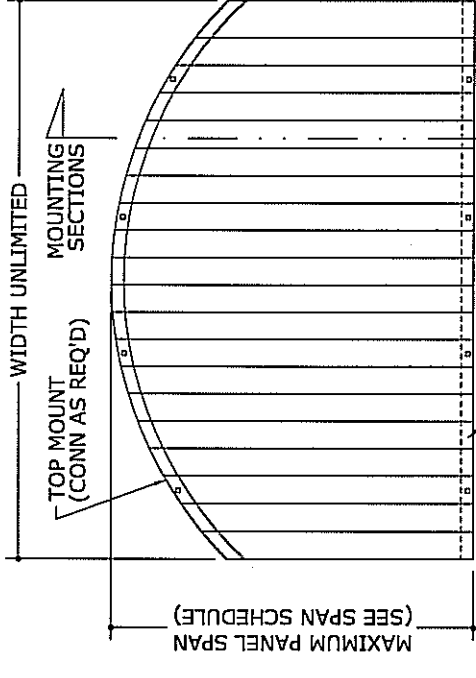

11 ALT. ARCH TOP*

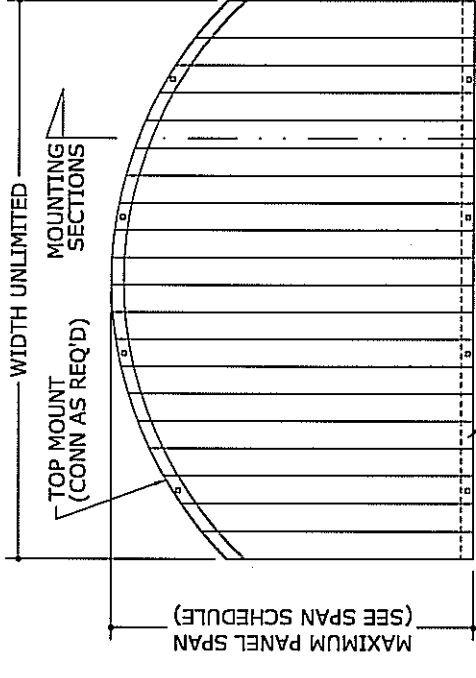

12 N.T.S.

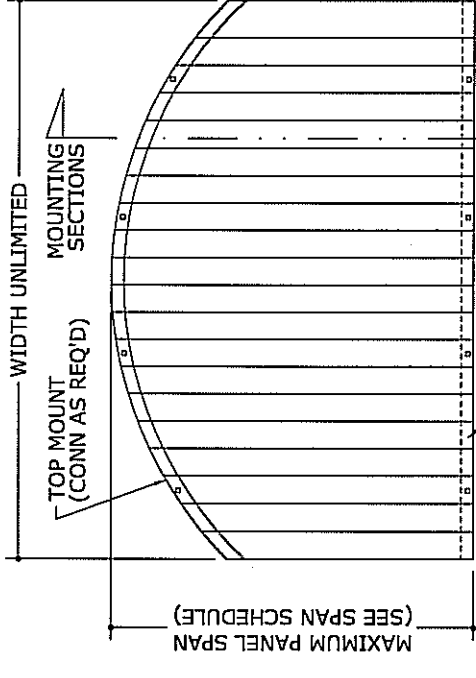

13 N.T.S.

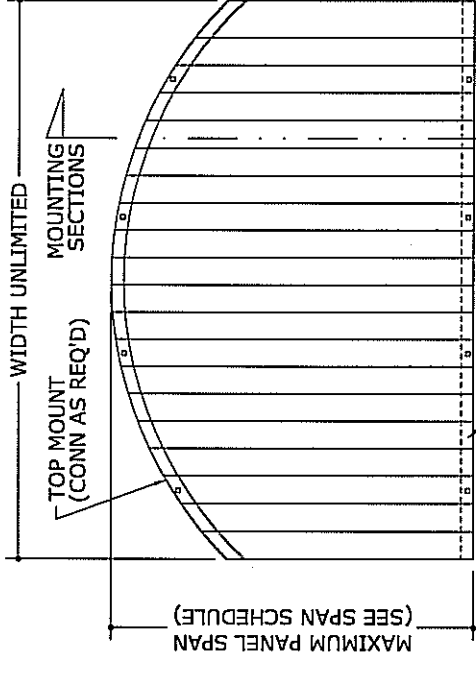

14 N.T.S.

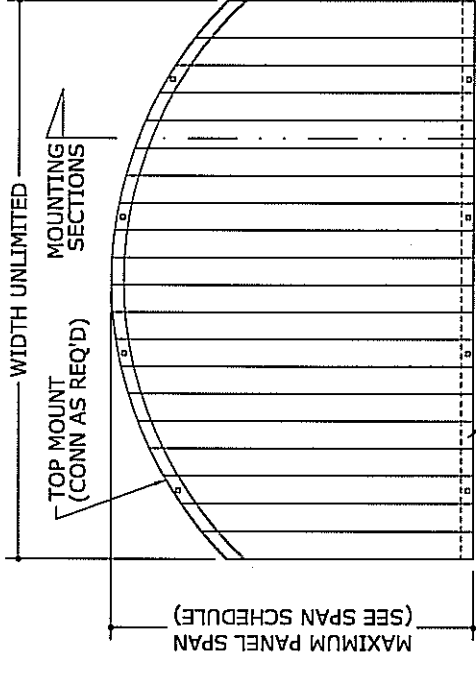

15 N.T.S.

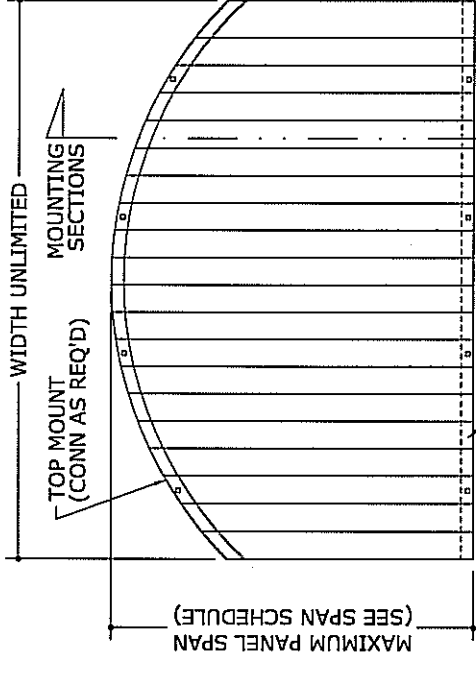

16 N.T.S.

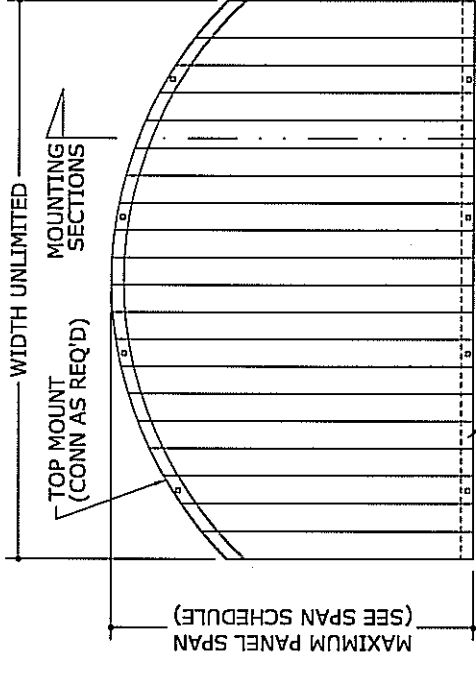

17 N.T.S.

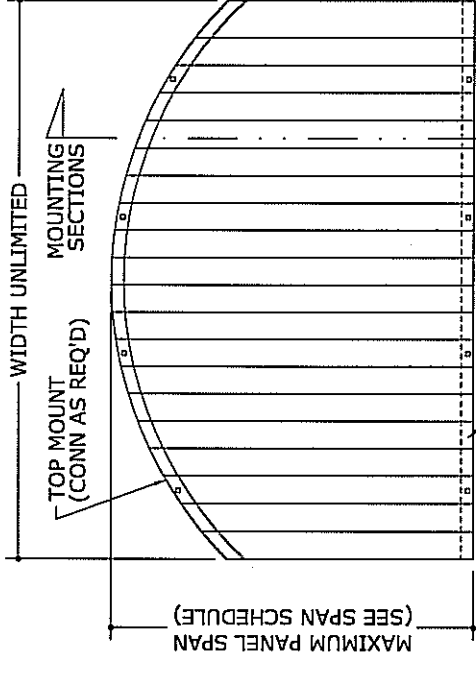

18 N.T.S.

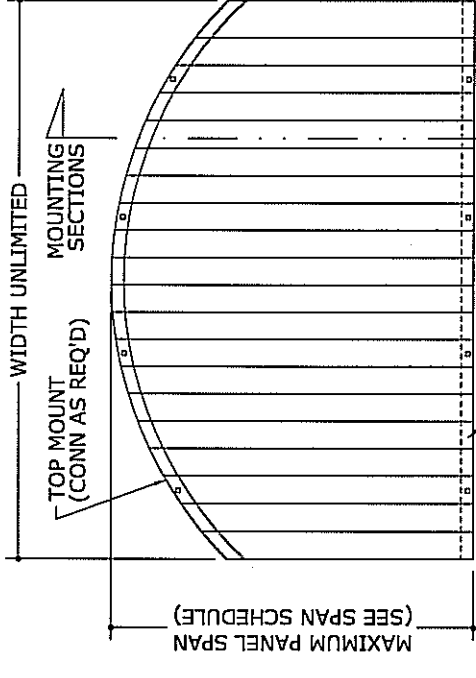

19 N.T.S.

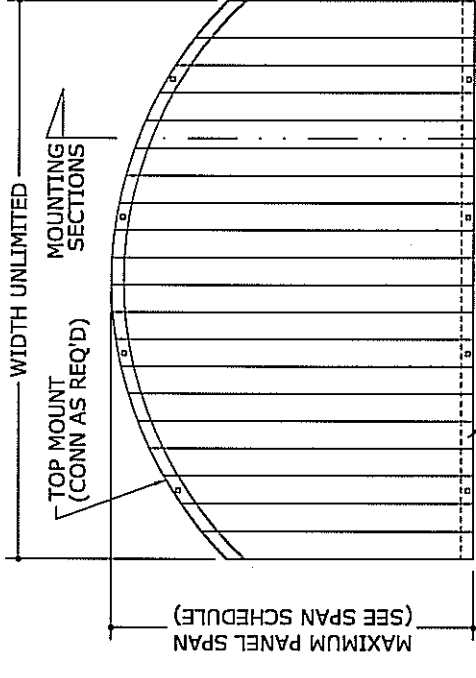

20 N.T.S.

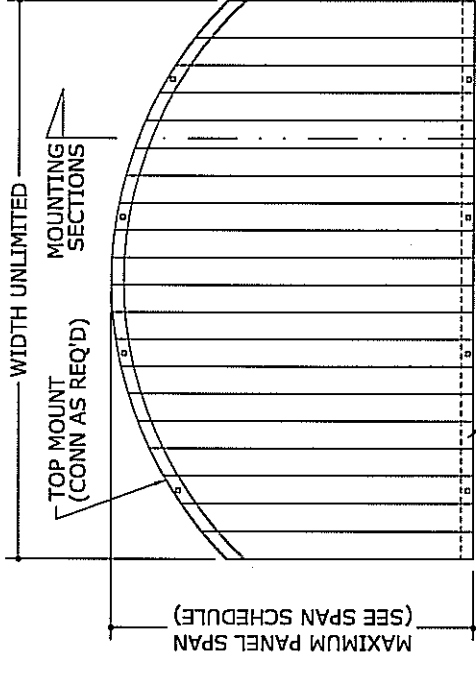

21 N.T.S.

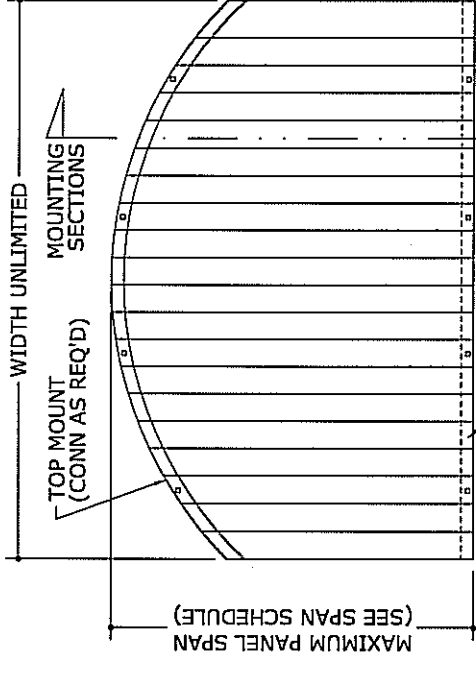

22 N.T.S.

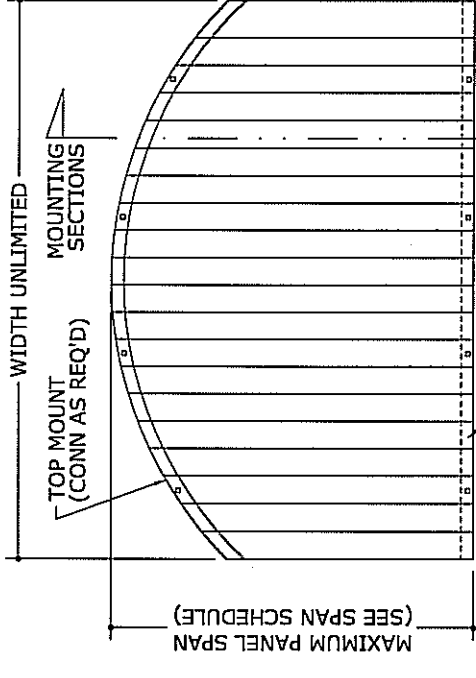

23 N.T.S.

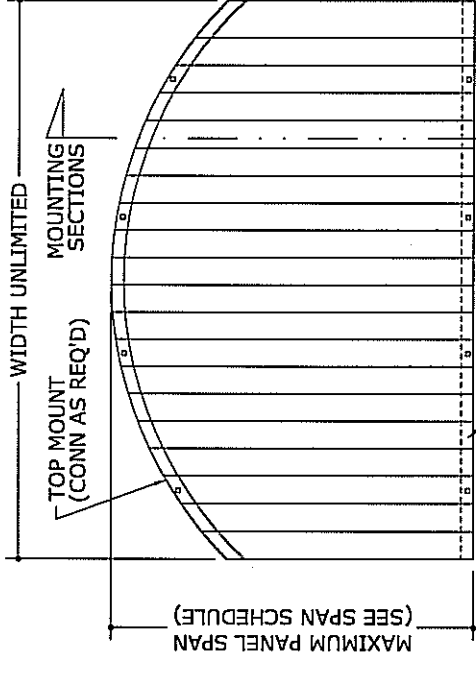

24 N.T.S.

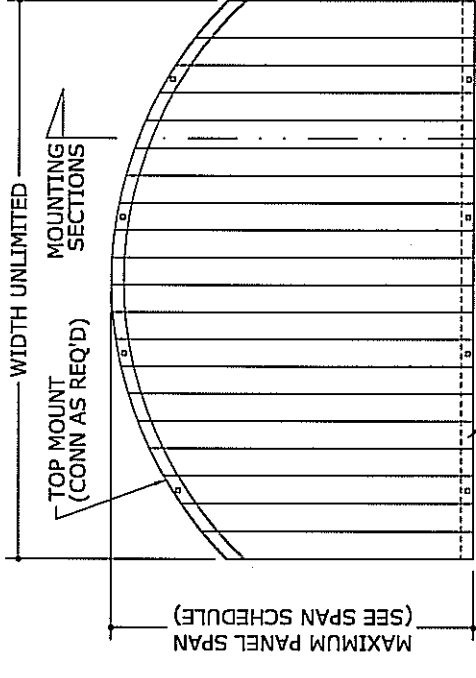

25 N.T.S.

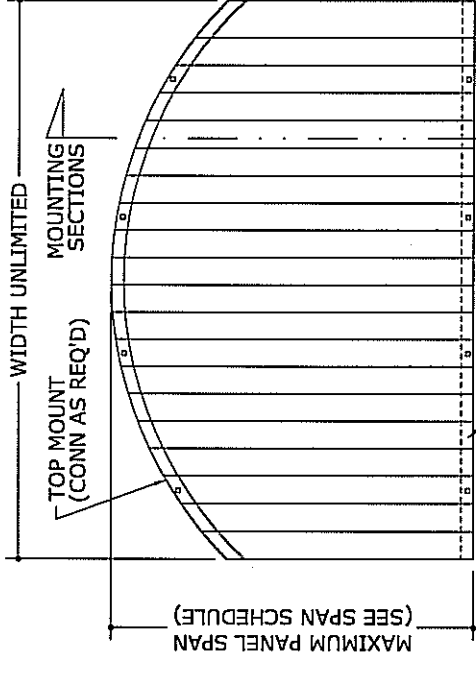

26 N.T.S.

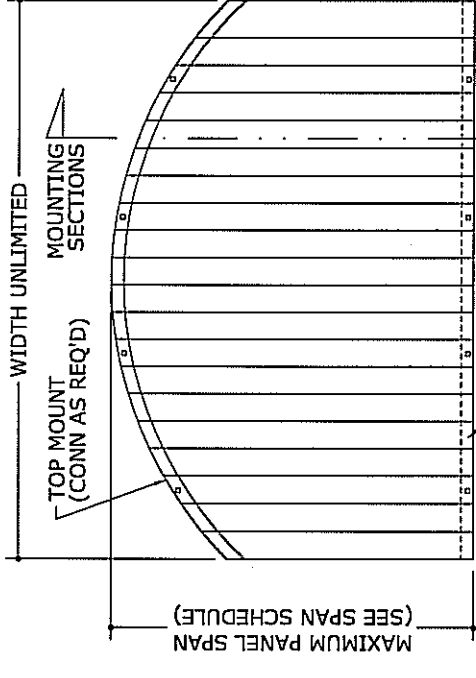

27 N.T.S.

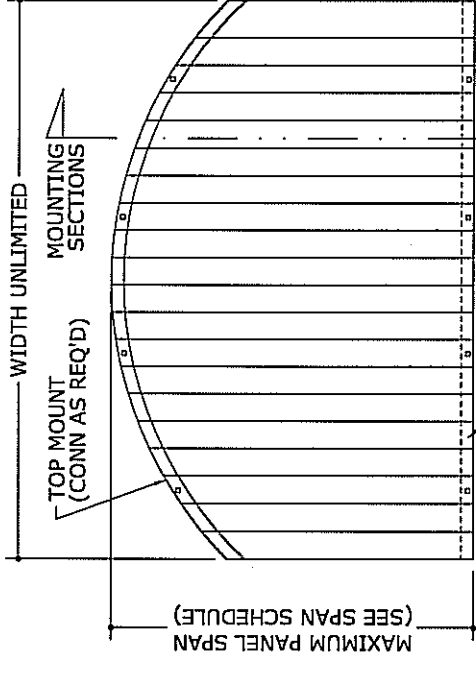

28 N.T.S.

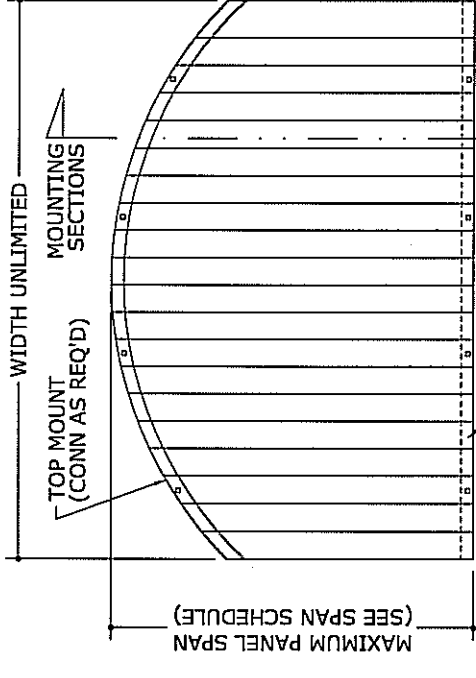

29 N.T.S.

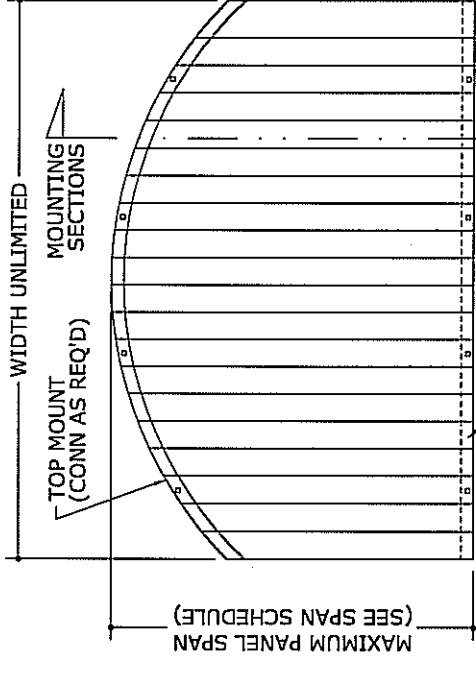

30 N.T.S.

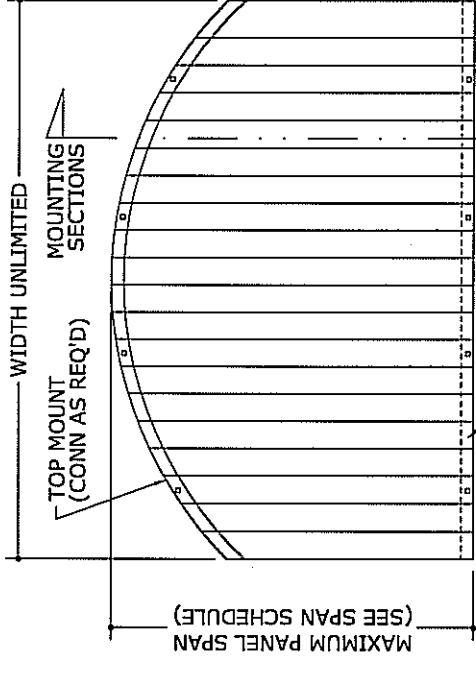

31 N.T.S.

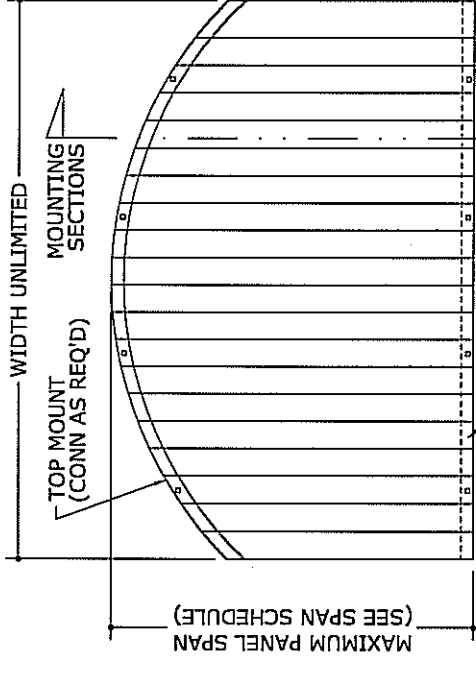

32 N.T.S.

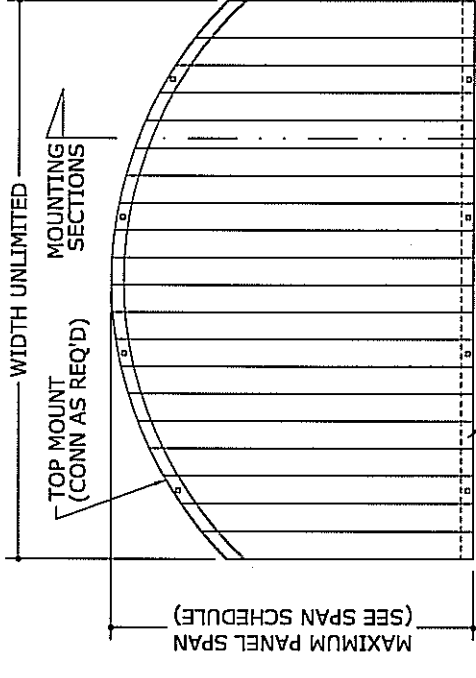

33 N.T.S.

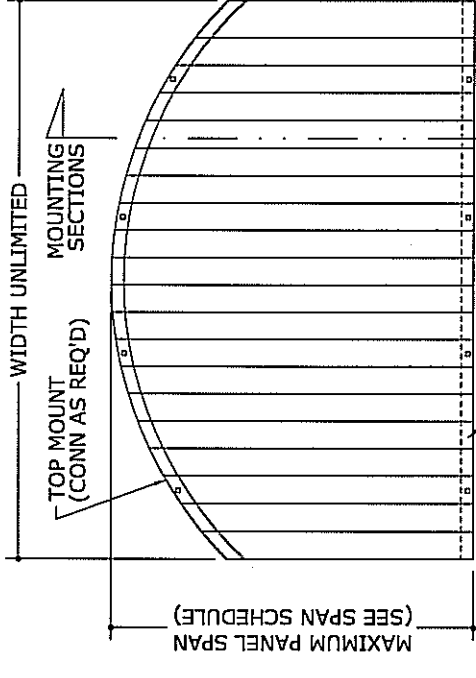

34 N.T.S.

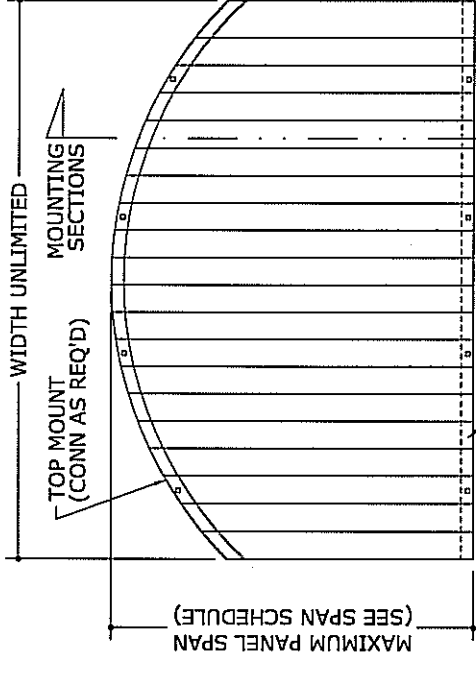

35 N.T.S.

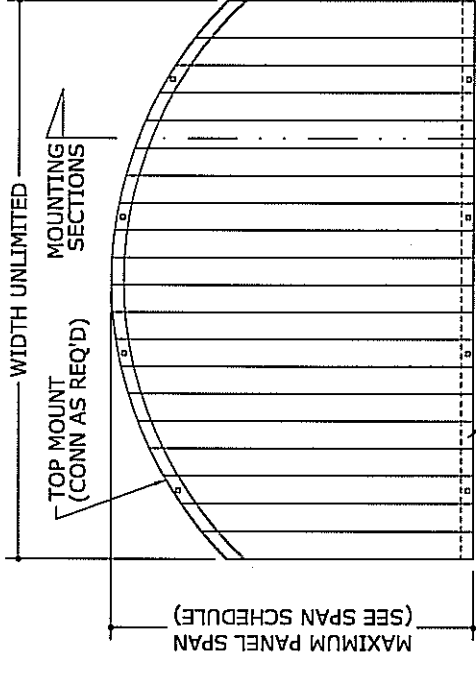

36 N.T.S.

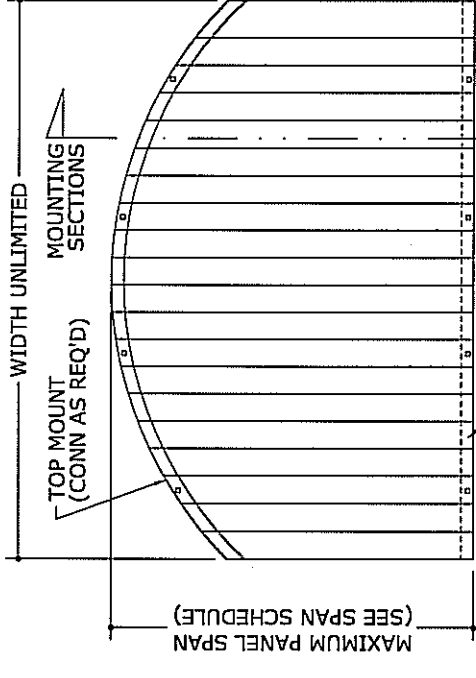

37 N.T.S.

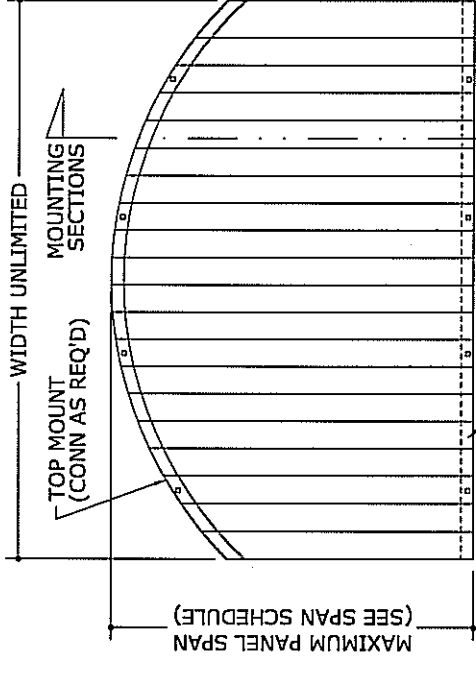

38 N.T.S.

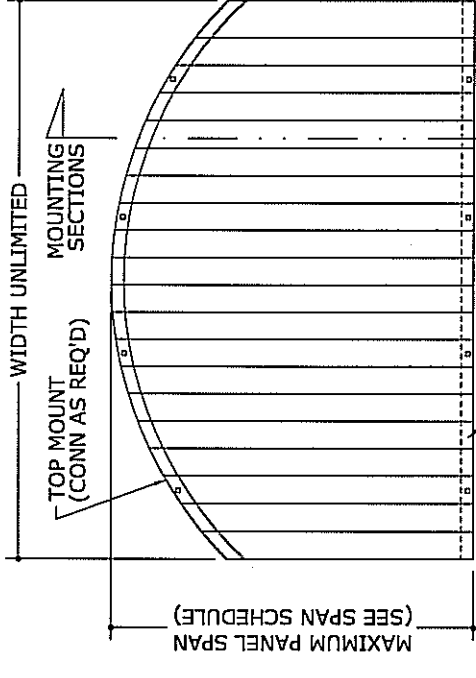

39 N.T.S.

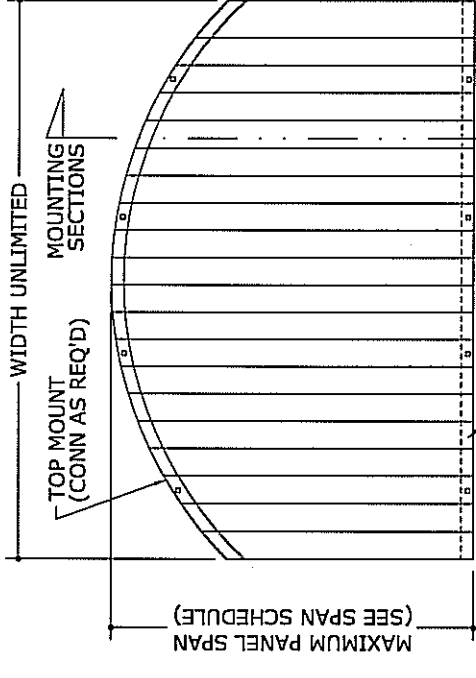

40 N.T.S.

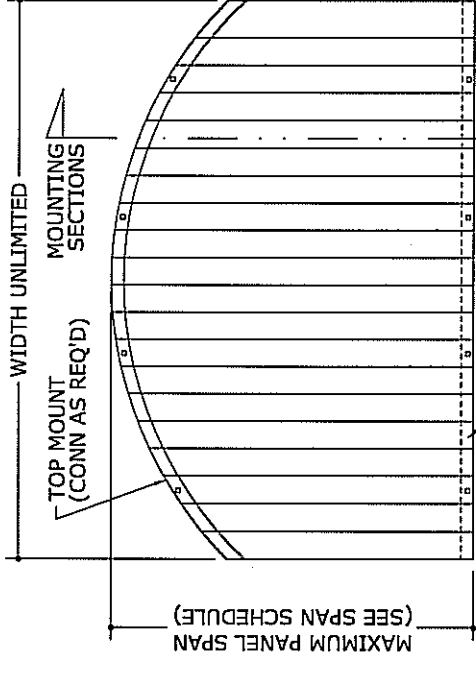

41 N.T.S.

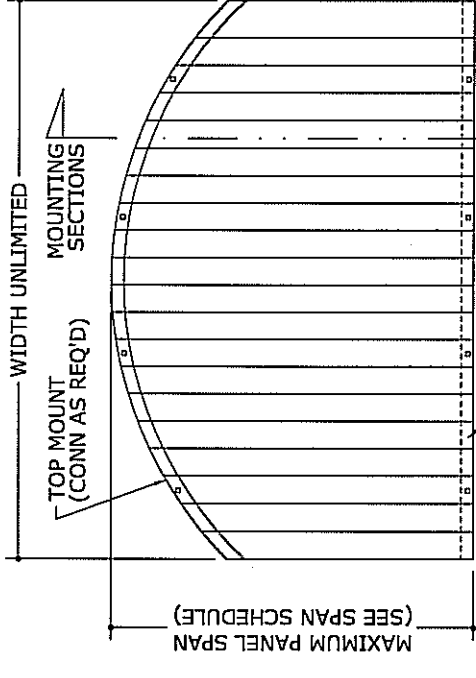

42 N.T.S.

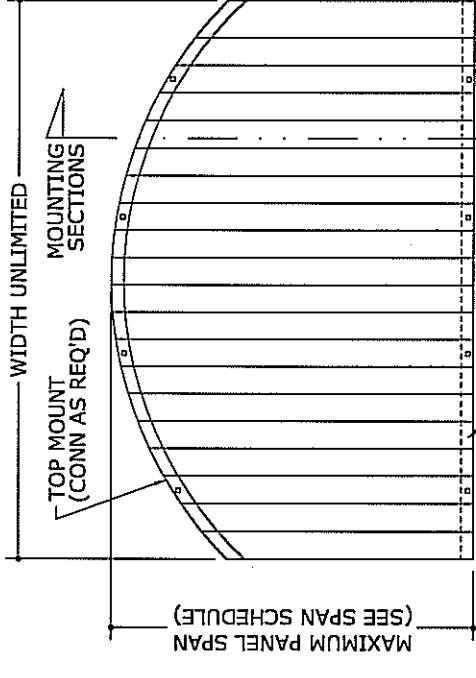

43 N.T.S.

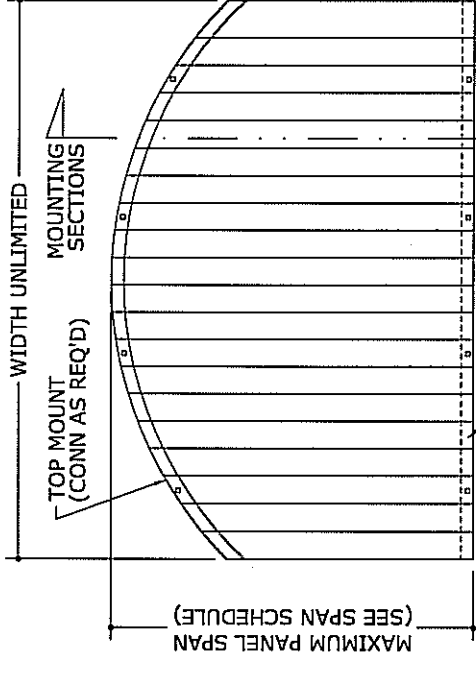

44 N.T.S.

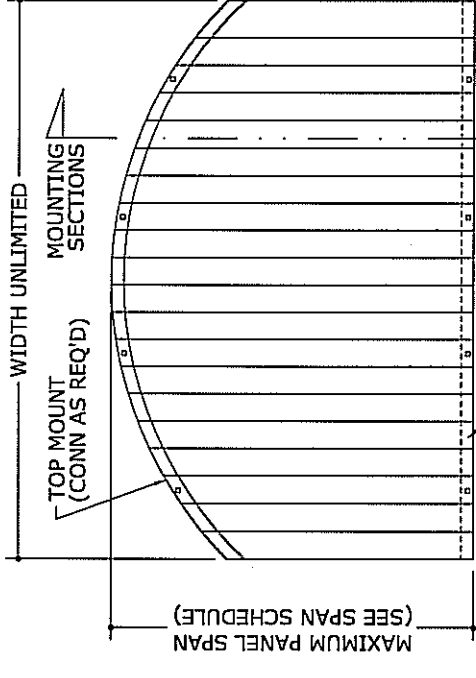

45 N.T.S.

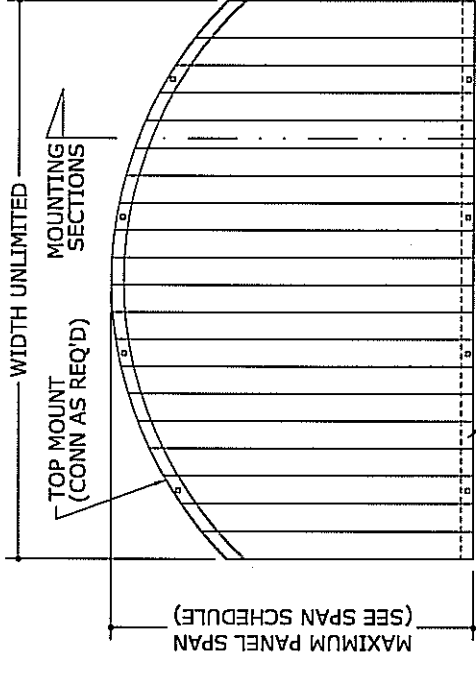

46 N.T.S.

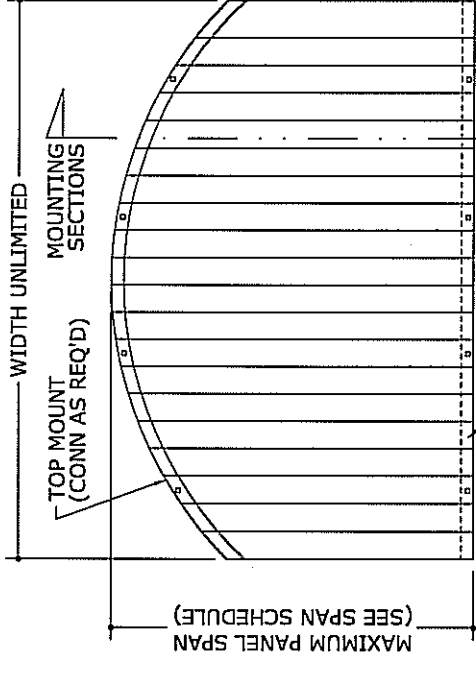

47 N.T.S.

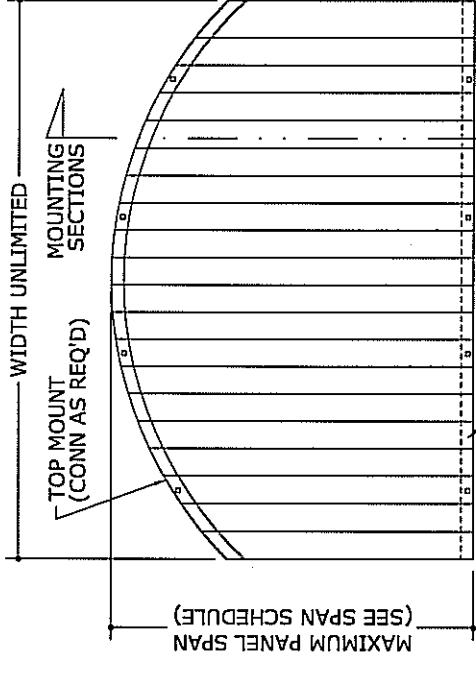

48 N.T.S.

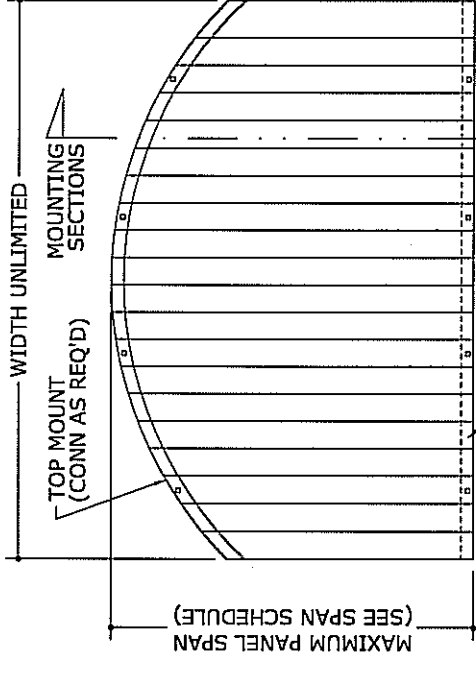

49 N.T.S.

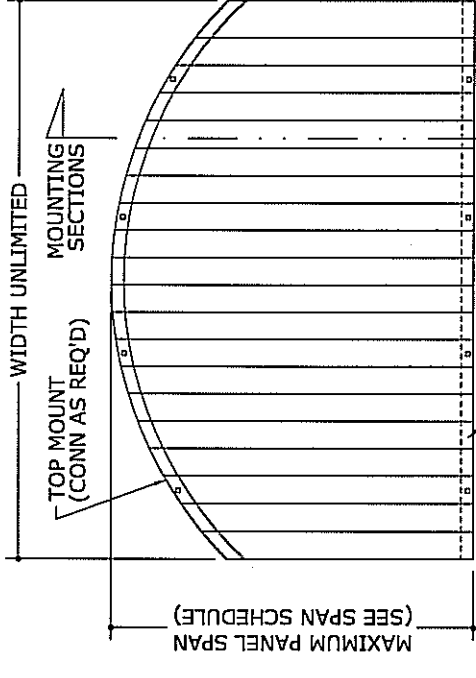

50 N.T.S.

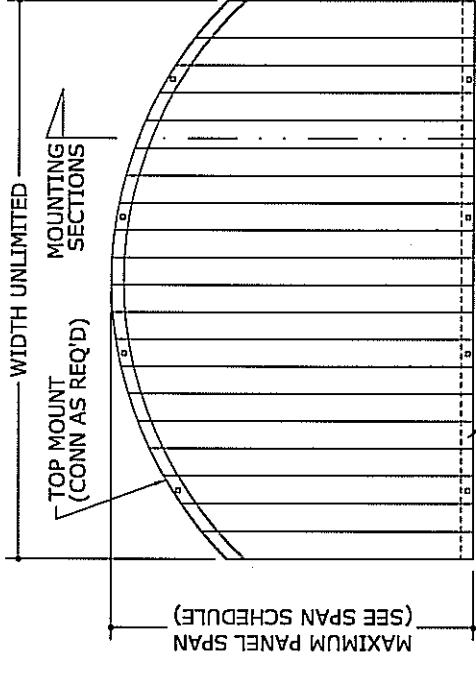

51 N.T.S.

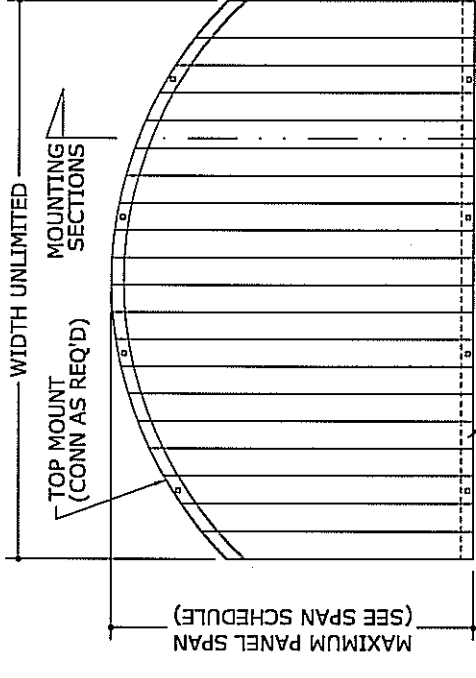

52 N.T.S.

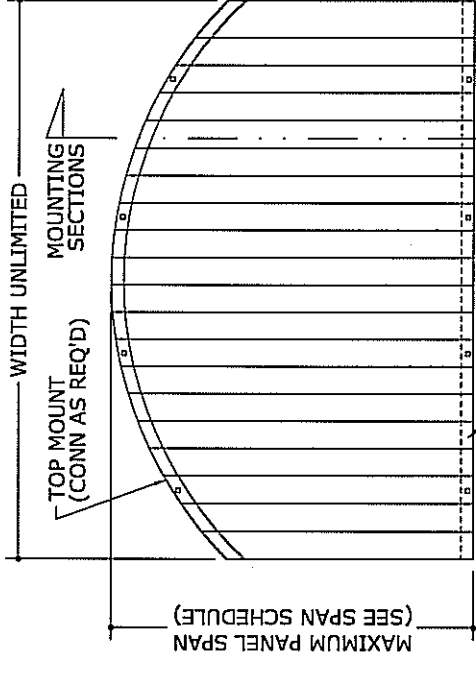

53 N.T.S.

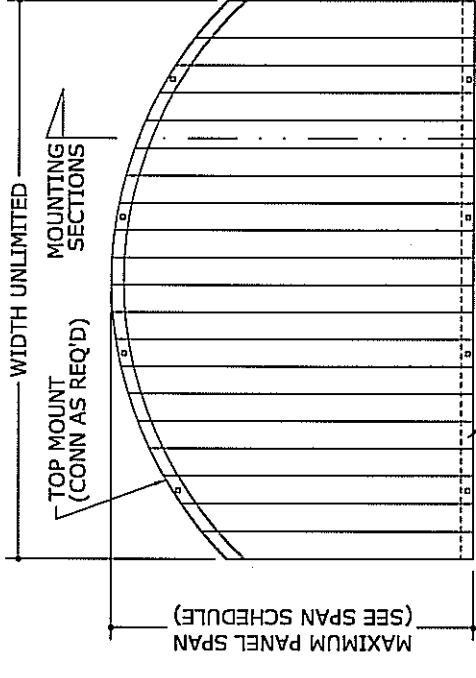

54 N.T.S.

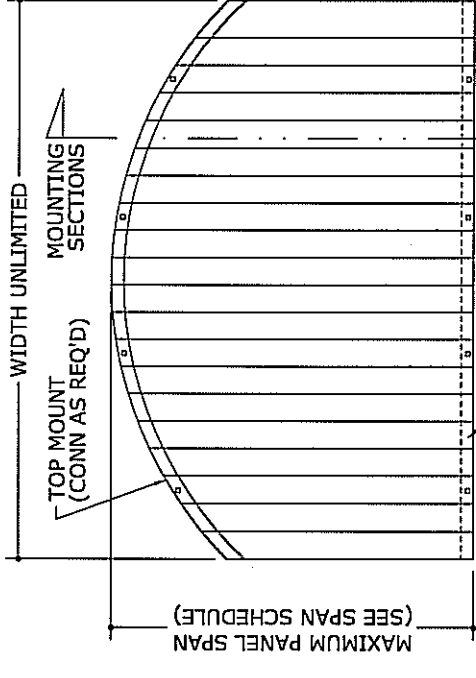

55 N.T.S.

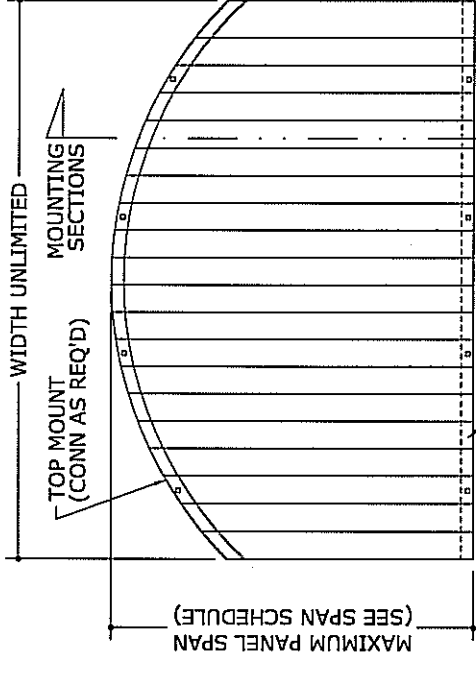

56 N.T.S.

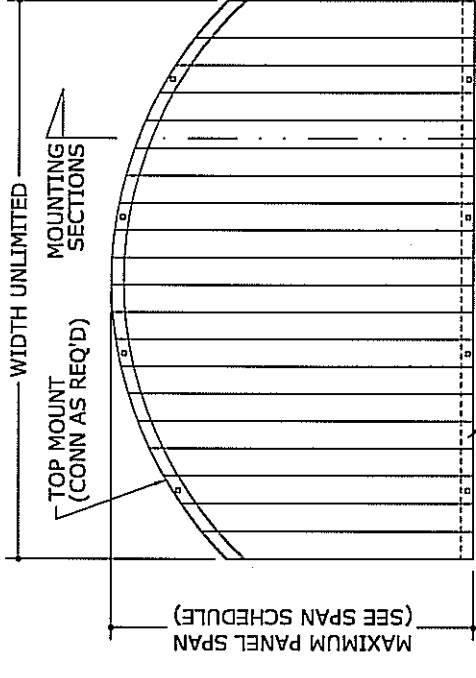

57 N.T.S.

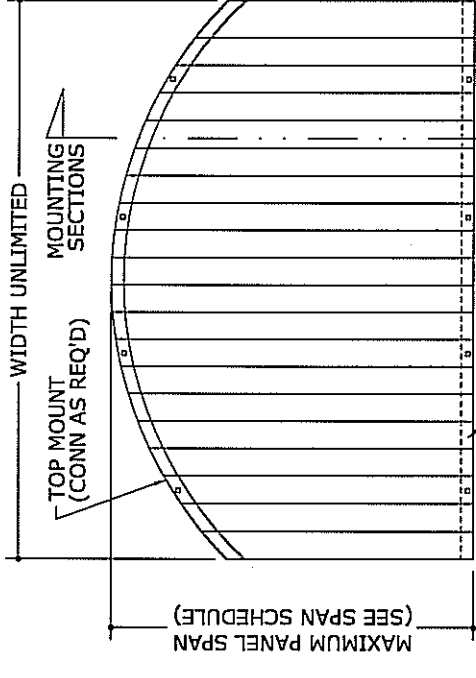

58 N.T.S.

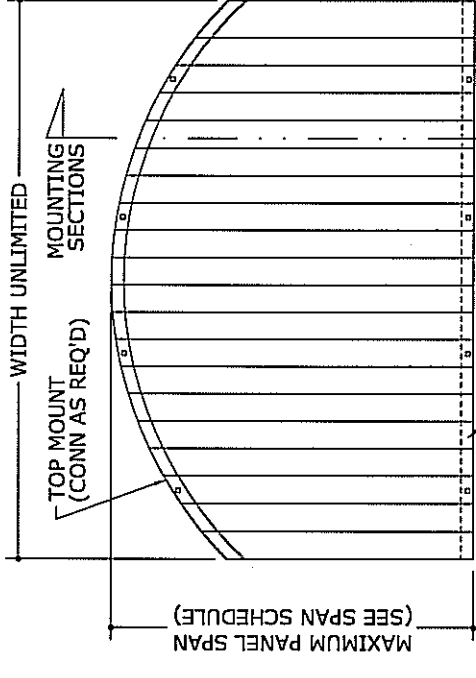

59 N.T.S.

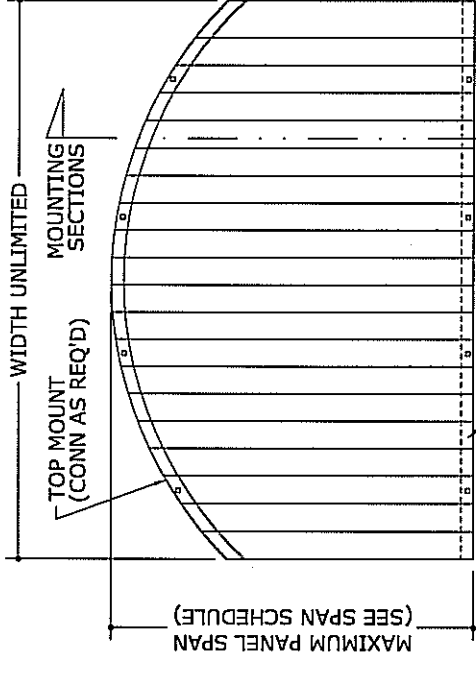

60 N.T.S.

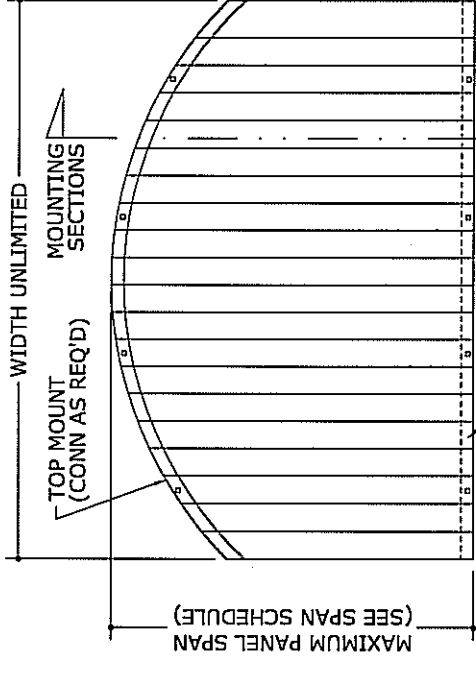

61 N.T.S.

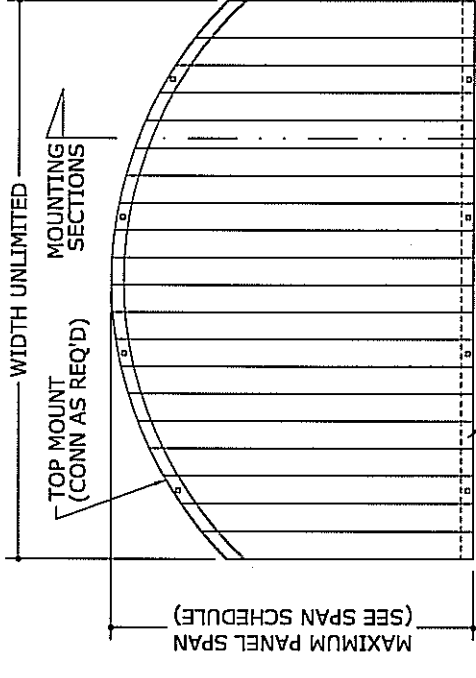

62 N.T.S.

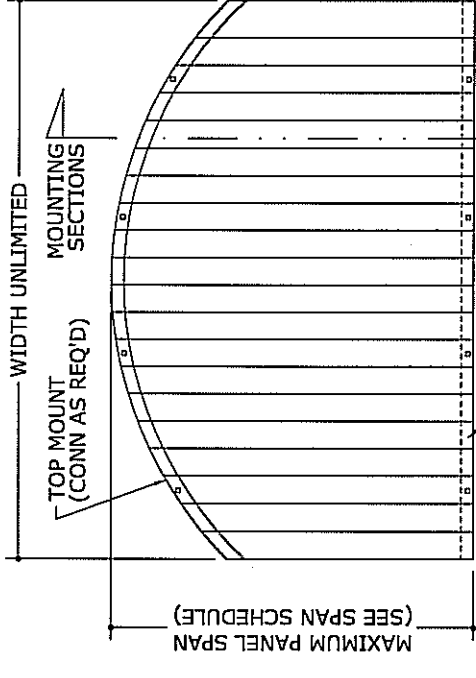

63 N.T.S.

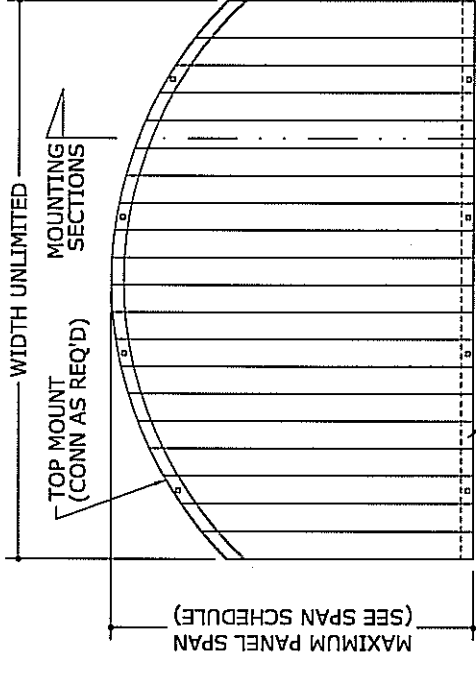

64 N.T.S.

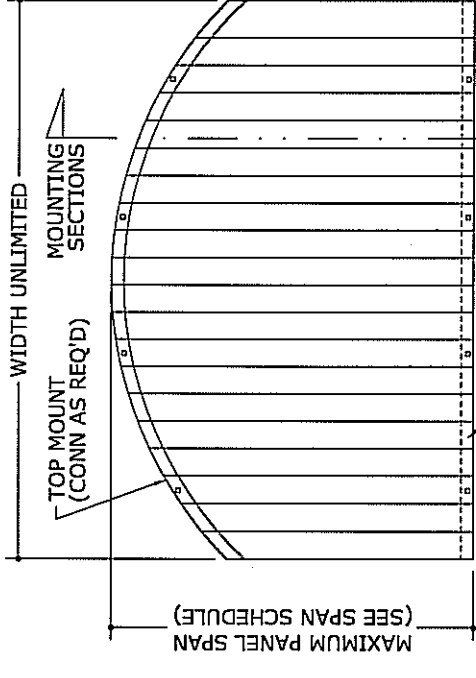

65 N.T.S.

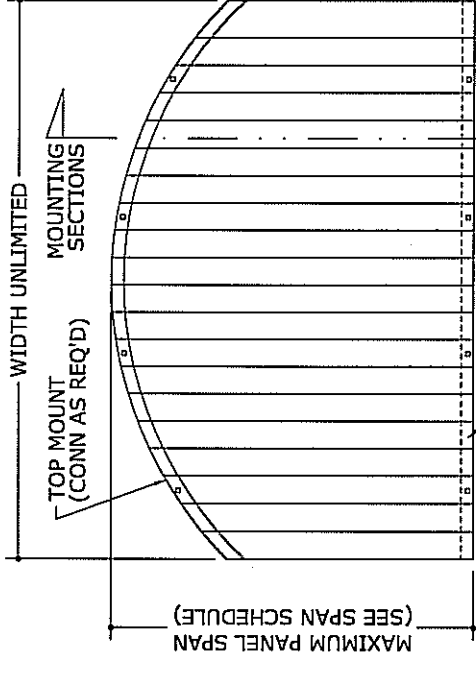

66 N.T.S.

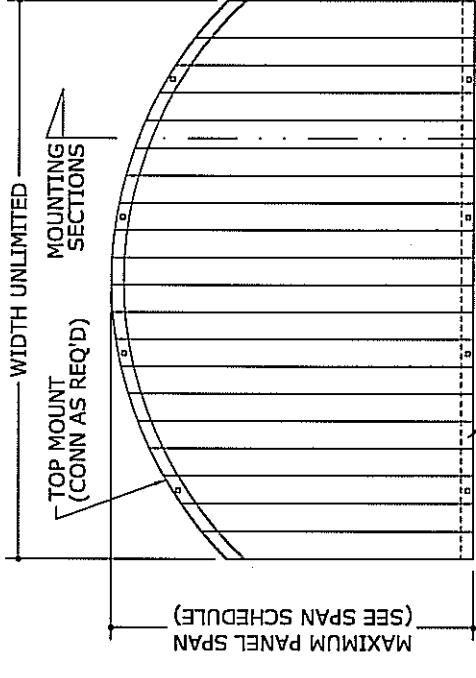

67 N.T.S.

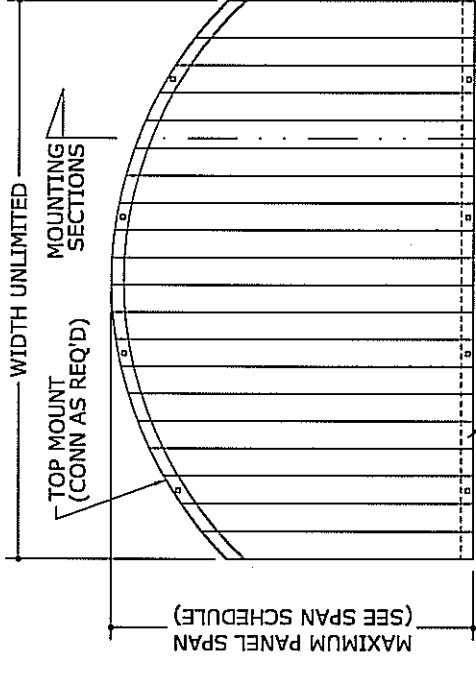

68 N.T.S.

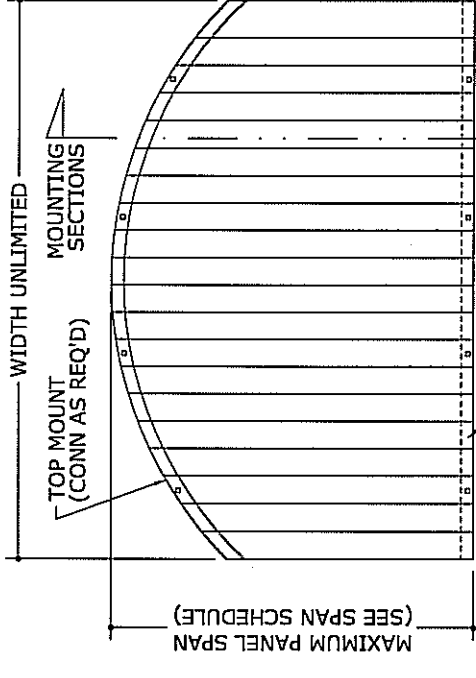

69 N.T.S.

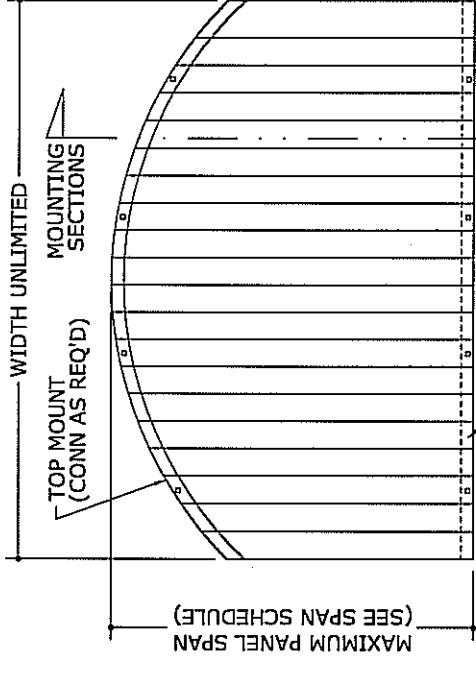

70 N.T.S.

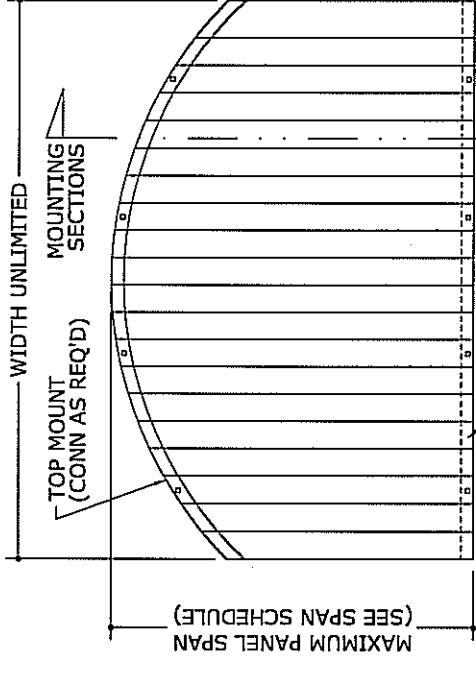

71 N.T.S.

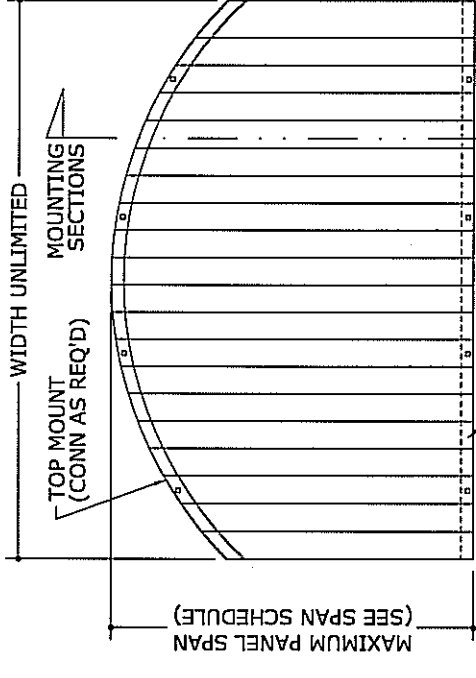

72 N.T.S.

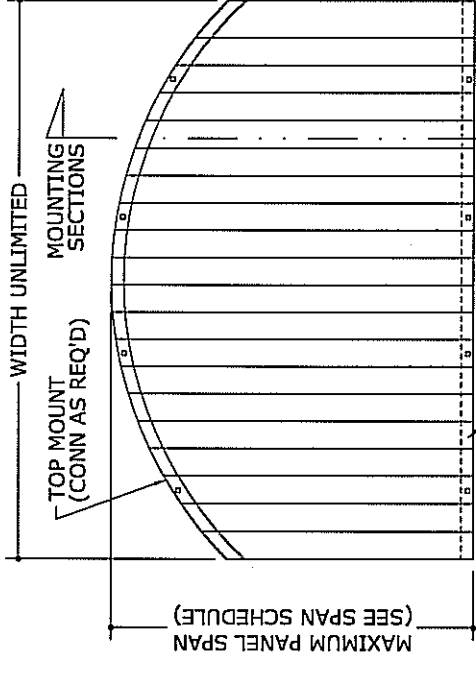

73 N.T.S.

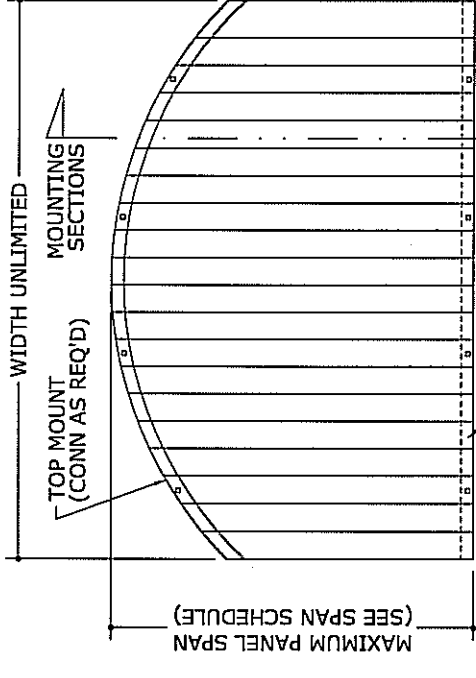

74 N.T.S.

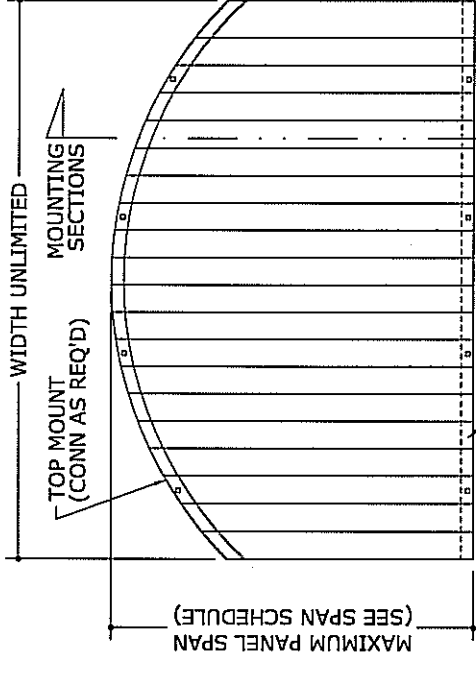

75 N.T.S.

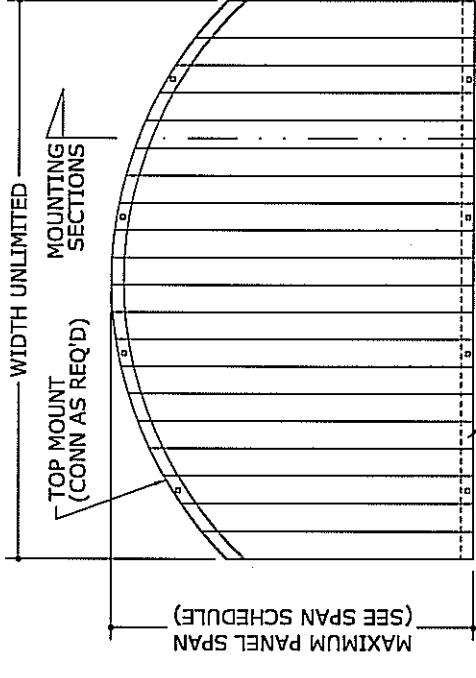

76 N.T.S.

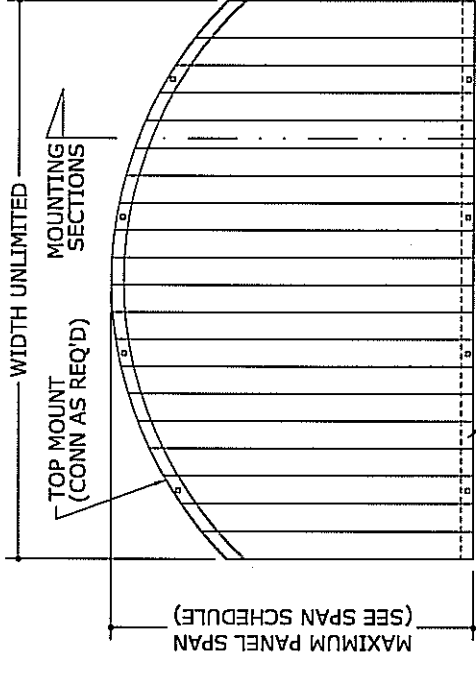

77 N.T.S.

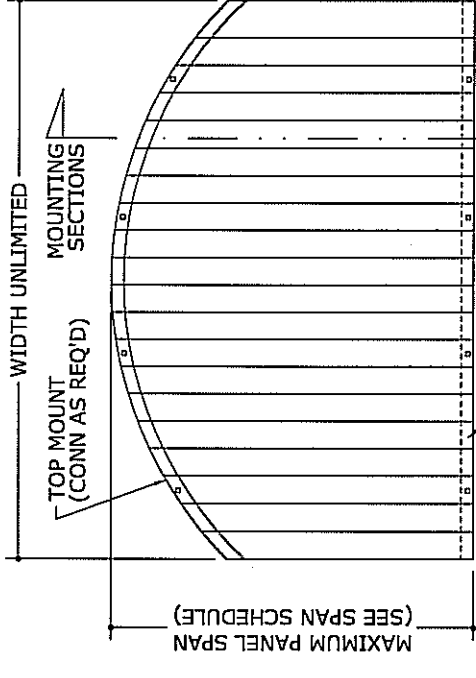

78 N.T.S.

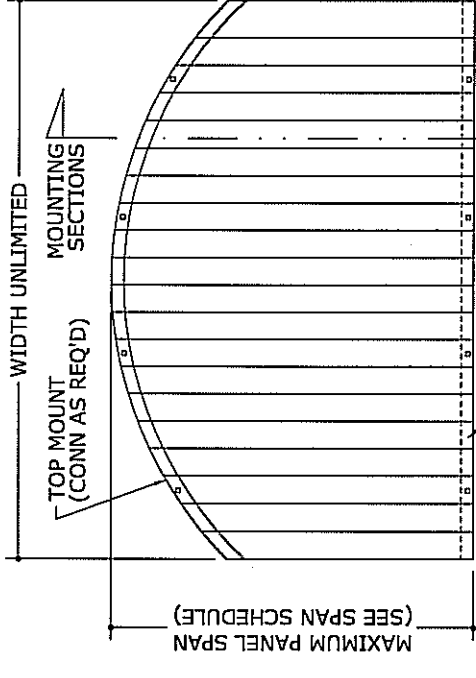

79 N.T.S.

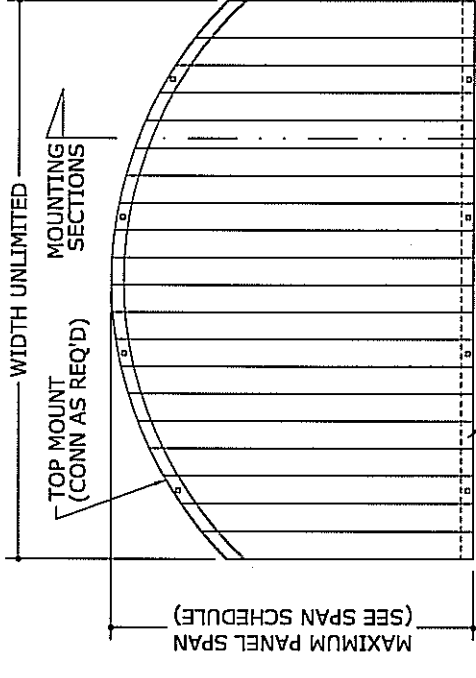

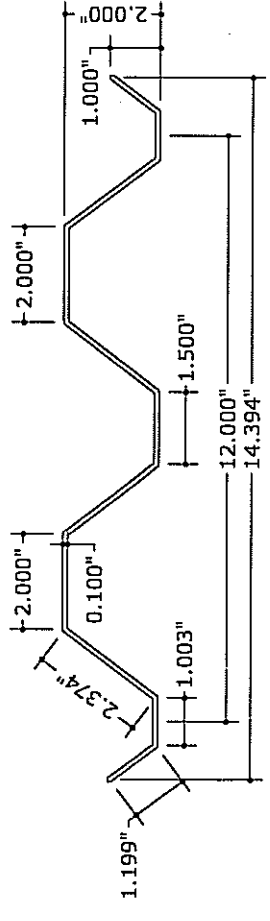

12 ALT. FULL PANEL PROFILE
N.T.S.
MOUNT WITH FASTENERS OR STUDS AT 13" O.C. MAX
(SEE GEN NOTE 6)

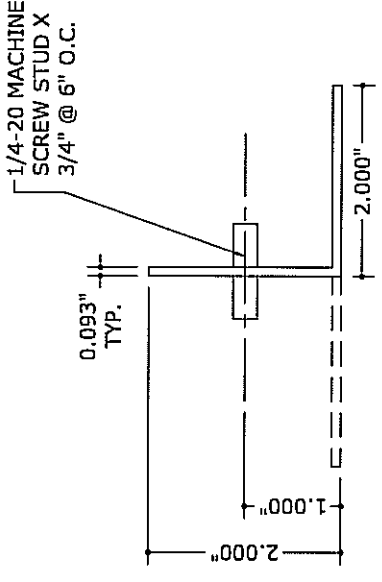

15 STUDDED ANGLE
6" = 1'-0"
1/4-20 MACHINE SCREW STUD X 3/4" @ 6" O.C.

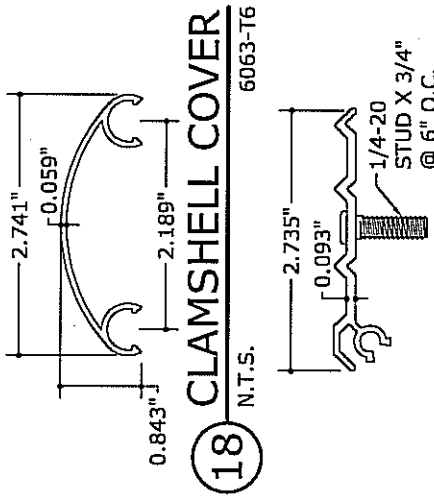

18 CLAMSHELL COVER
N.T.S.
6063-T6

19 CLAMSHELL TRACK
N.T.S.
6063-T6

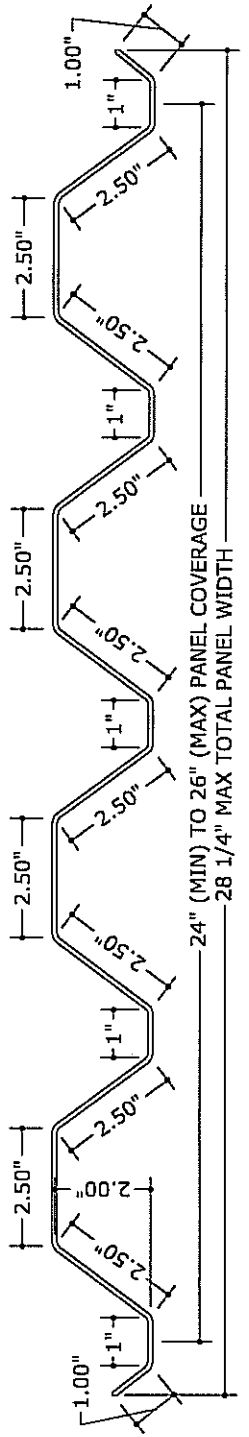

11 "CLEARMAX"™ DOUBLE-WIDE PANEL PROFILE
3" = 1'-0"
MOUNT WITH FASTENERS OR STUDS AT 13" O.C. MAX
(SEE GEN NOTE 6)

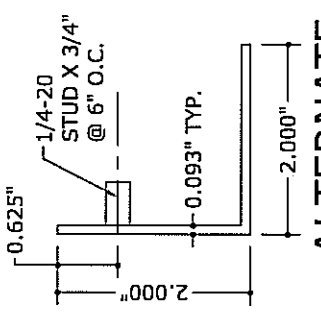

14 ALTERNATE STUD ANGLE
6" = 1'-0"
1/4-20 STUD X 3/4" @ 6" O.C.

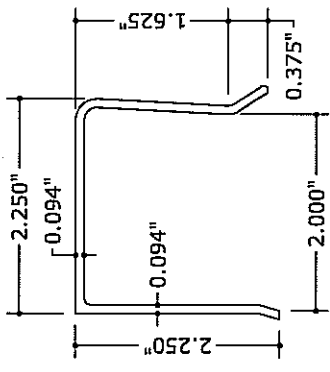

17 ALTERNATE U-HEADER
N.T.S.
6063-T6

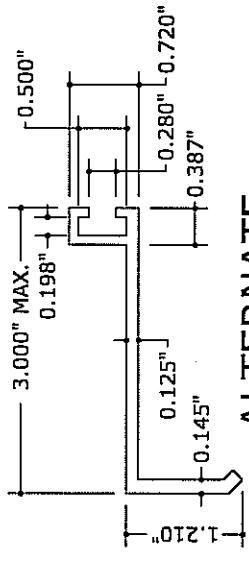

13 ALTERNATE B.O. 'F' TRACK
6" = 1'-0"
0.125" 0.145" 0.387" 0.280" 0.720" 0.500" 0.198"

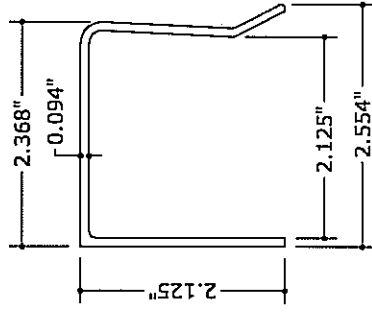

16 U-HEADER
N.T.S.
6063-T6

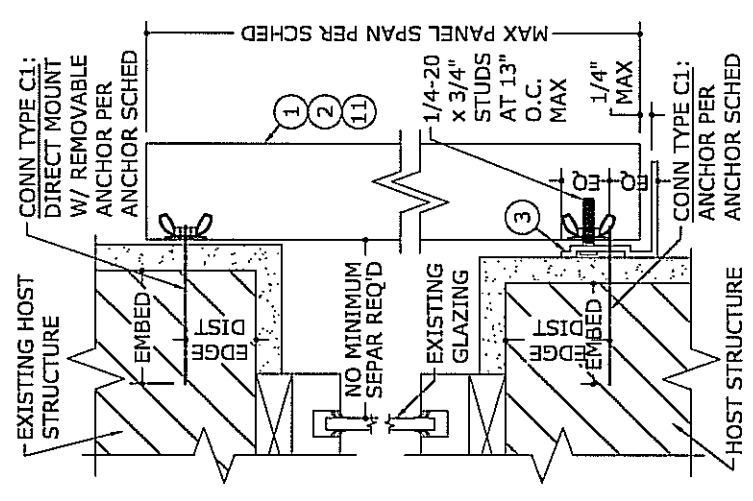

1 MOUNTING SECTION
3 3" = 1'-0"

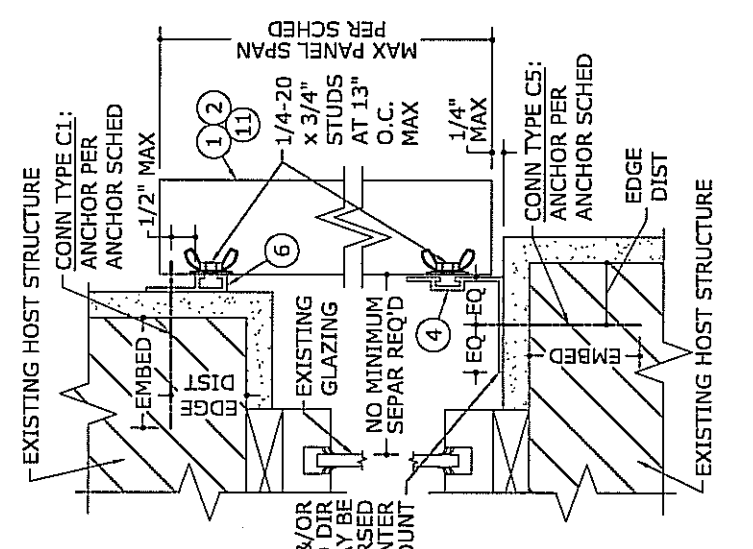

2 MOUNTING SECTION
3 3" = 1'-0"

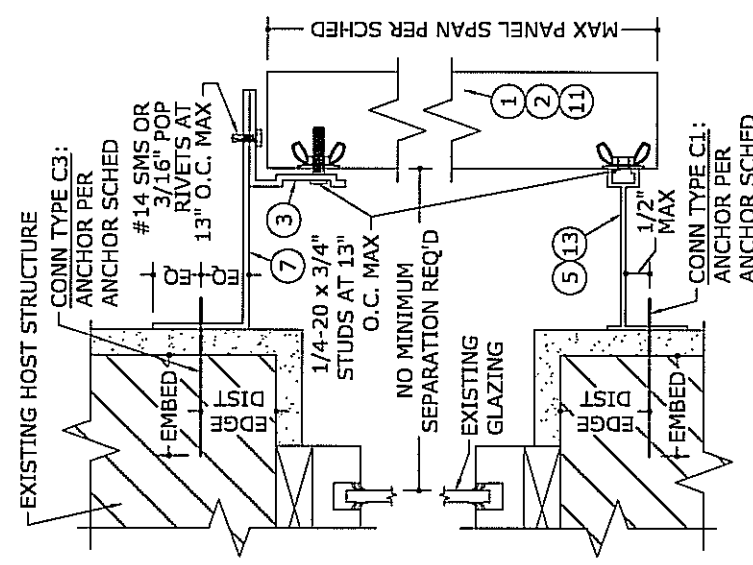

3 MOUNTING SECTION
3 3" = 1'-0"

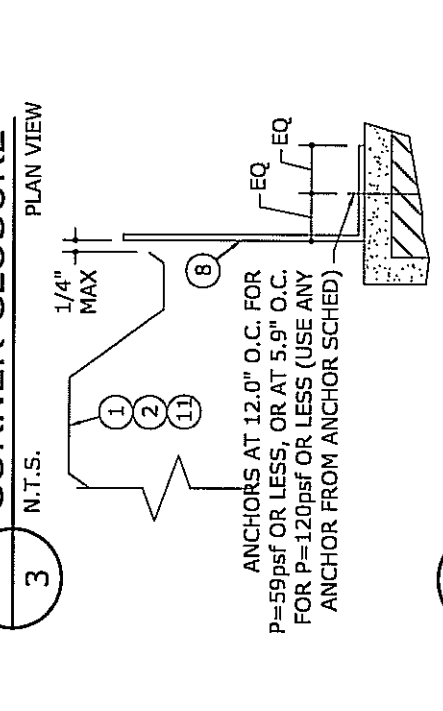
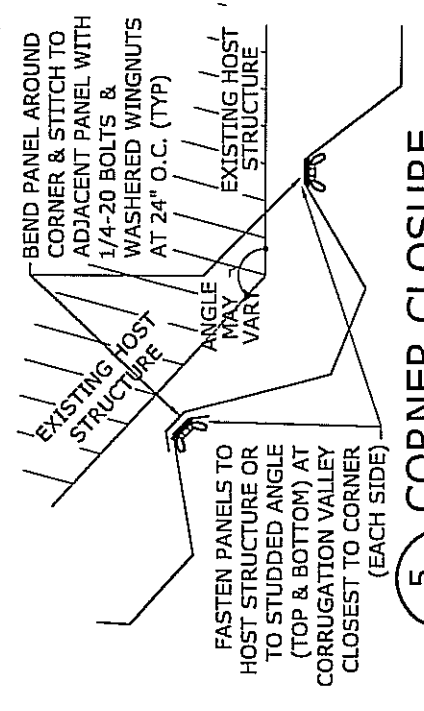

FRANK L. BENNARDI, P.E.
#PED046549

1-2-13/2008

ENGINEERING EXPRESS

160 SW 12th AVENUE, #106
DEERFIELD BEACH, FL 33442
PH: (954) 354-0660 FAX: (954) 354-0443
WWW.ENGGEXP.COM

CERT OF AUTH #8865
A FRANK L. BENNARDI, P.E., INC. INNOVATION

Transparent Protection Systems, Inc.

6643 42nd Terrace North
West Palm Beach, FL 33407

TPS

CLEARGUARD POLYCARBONATE STORM PANELS
FOR USE OUTSIDE THE HVHZ
FLORIDA STATEWIDE APPROVAL

REVISIONS

DATE	BY	DESCRIPTION
8/17/04	FLB	ORIG ISSUE
9/15/05	FLB	2ND ISSUE
8/5/05	FLB	2004 FBC
8/5/05	FLB	CL MAX PROFILE ADDED
2/6/06	FLB	2007 FBC REVISION
12/29/08	KL	CL

REMARKS
THIS DRAWING IS THE PROPERTY OF FRANK L. BENNARDI, P.E. AND SHALL NOT BE REPRODUCED OR TRANSMITTED IN ANY FORM OR BY ANY MEANS, ELECTRONIC OR MECHANICAL, INCLUDING PHOTOCOPYING, RECORDING, OR BY ANY INFORMATION STORAGE AND RETRIEVAL SYSTEM, WITHOUT THE WRITTEN PERMISSION OF FRANK L. BENNARDI, P.E. ALL RIGHTS RESERVED.

SCALE: 1" = 1'-0"

PAGE DESCRIPTION: 05

OF 5

3

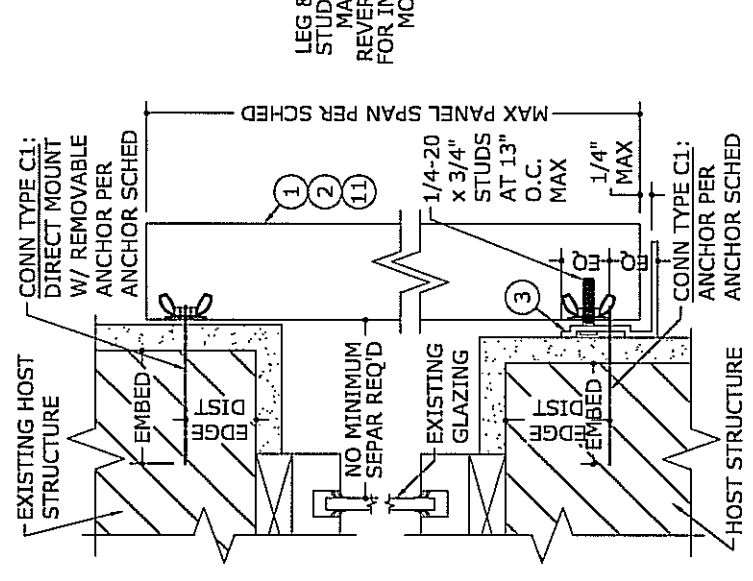

4 MOUNTING SECTION
3 3" = 1'-0"

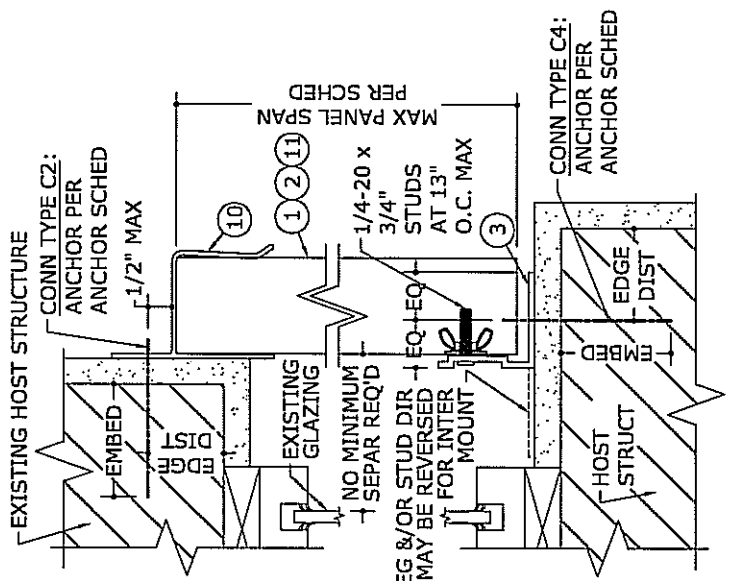

7 WALL MOUNT CLOSURE
3 3" = 1'-0"

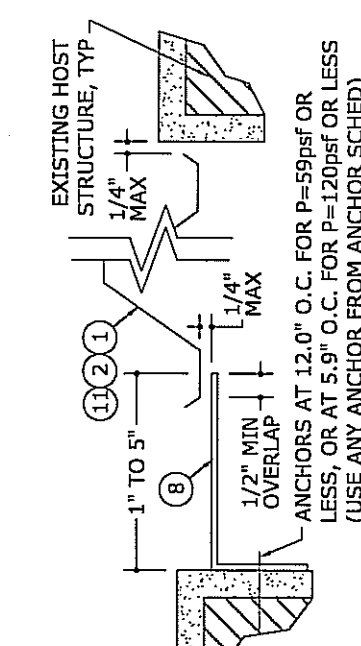

MAXIMUM PANEL SPAN SCHEDULE (POSITIVE CONN.)

LOAD (psf)	MAX SPAN (ft)
25	11'-4"
30	10'-4"
35	9'-7"
40	8'-11"
45	8'-5"
50	8'-0"
55	7'-7"
60	7'-4"
65	7'-0"
70	6'-7"
75	6'-1"
80	5'-9"
90	5'-1"
100	4'-7"
110	4'-2"
120	3'-10"

MAXIMUM PANEL SPAN SCHEDULE (W/ "H" HEADER)

LOAD (psf)	MAX SPAN (ft)
17.3	8'-7"
24.2	7'-9"
34.6	7'-0"
41.6	6'-0"
55.4	5'-0"
104	4'-0"

MAXIMUM PANEL SPAN SCHEDULE (W/ "U" HEADER)

MAX SPAN (ft)	MAX DESIGN PRESSURES POSITIVE (psf)	MAX DESIGN PRESSURES NEGATIVE (psf)
6'-3"	35	38
5'-3"	48	48
4'-4"	78	80

MAXIMUM SPAN SCHEDULE NOTES:

1. SPANS SHOWN IN "MAX PANEL SPAN SCHEDULES" ARE MAXIMUM ALLOWABLE SPANS AT EACH RESPECTIVE DESIGN PRESSURE.
2. THE <POSITIVE CONNECTION> SPAN SCHEDULE MAY BE USED TO DETERMINE MAXIMUM ALLOWABLE SPANS FOR PANELS INSTALLED USING ANY COMBINATION OF MOUNTING EXTRUSIONS INVOLVING A POSITIVE CONNECTION - I.E. ALL INSTALLATIONS WHICH DO NOT INCLUDE AN "H" OR "U" HEADER.
3. THE <WITH "H" HEADER> SPAN SCHEDULE SHALL BE USED FOR ALL INSTALLATIONS WHICH INCLUDE AN "H" HEADER.
4. THE <WITH "U" HEADER> SPAN SCHEDULE SHALL BE USED FOR ALL INSTALLATIONS WHICH INCLUDE A "U" HEADER
4. TABLES ARE VALID FOR PANELS MOUNTED HORIZONTALLY OR VERTICALLY. SPAN DIRECTION IS ALWAYS PERPENDICULAR TO LINE OF ANCHORAGE.

9 PANEL OVERLAP
3 N.T.S.





ENGINEERING EXPRESS
160 SW 12th Avenue, #106
Deerfield Beach, FL 33442
PH: (954) 354-0660 FAX: (954) 354-0443
WWW.ENGGXP.COM
CERT OF AUTH #8885
A FRANK L. BENNARDO, P.E., INNOVATION

TPS
Transparent Protection Systems, Inc.
6643 42nd Terrace North
West Palm Beach, FL 33407
CLEARGUARD POLYCARBONATE STORM PANELS
FOR USE OUTSIDE THE HVHZ
FLORIDA STATEWIDE APPROVAL

REMARKS	DATE	DRWN	CHKD
ORIG ISSUE	08/17/04	CL	FLB
2ND ISSUE	09/15/05	CL	FLB
2004 FBC	08/05/05	CL	FLB
ClearMAX PROFILE ADDED	2/6/06	CL	FLB
2007 FBC REVISION	12/29/08	KL	CL

THIS DOCUMENT IS THE PROPERTY OF FRANK L. BENNARDO, P.E. AND SHALL NOT BE REPRODUCED IN WHOLE OR PART WITHOUT WRITTEN CONSENT OF FRANK L. BENNARDO, P.E. ALTERATIONS, ADDITIONS, DELETIONS OR OTHER MARKS TO THIS DOCUMENT ARE NOT PERMITTED AND WILL BE AT THE USER'S SOLE RISK.

COPYRIGHT FRANK L. BENNARDO P.E.
08-TPS-0008
SCALE: 1/8" = 1'-0"
PAGE DESCRIPTION:
4 OF 5

- ALUMINUM OR GALVANIZED STEEL SPACER:
- REQUIRED ONLY FOR EIFS, ICF, OR OTHER MALLEABLE FINISHES.
 - OPTIONAL FOR STUCCO, BRICK, OR OTHER RIGID FINISHES.

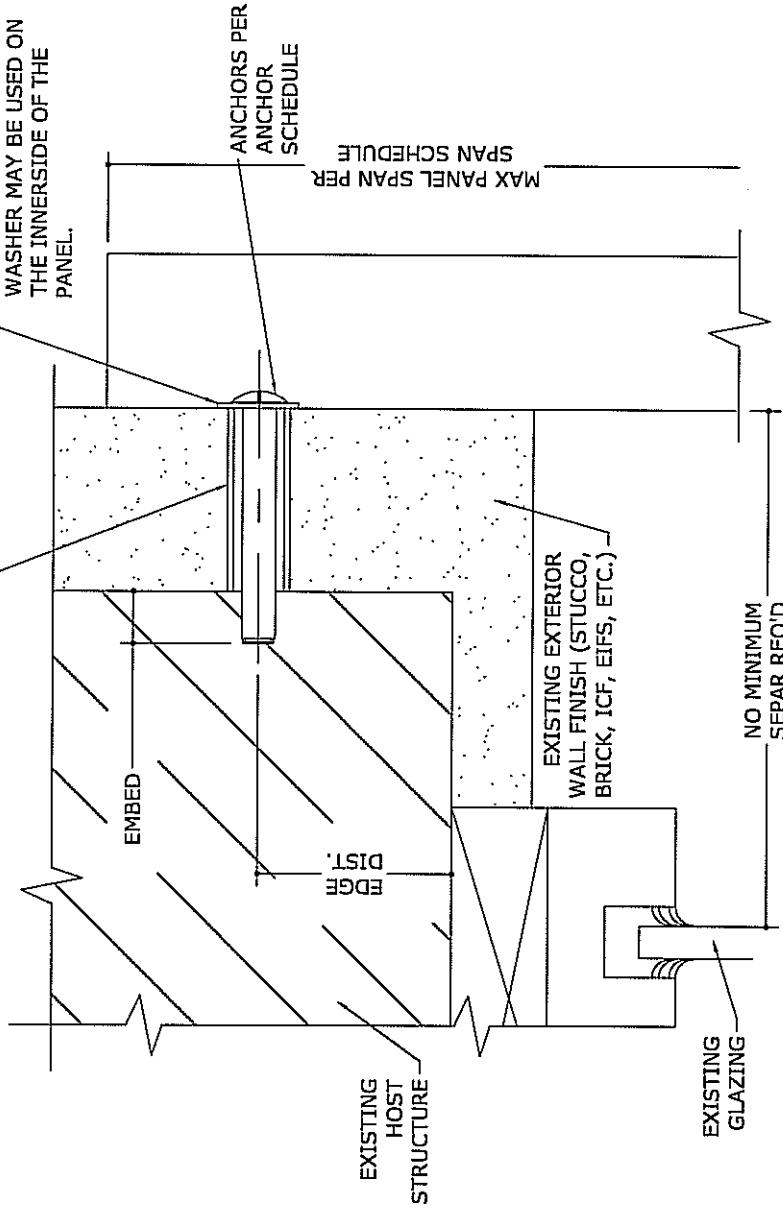

NOTE: SHUTTER SYSTEM MAY BE ANCHORED THROUGH EXTERIOR WALL FINISH TO HOST STRUCTURE WITH ANY MOUNTING CONDITION SHOWN HEREIN.

MOUNTING SECTION THRU EXTERIOR WALL FINISH (BRICK, ICF, EIFS, ETC.)
VERT SECTION
5/4 N.T.S.

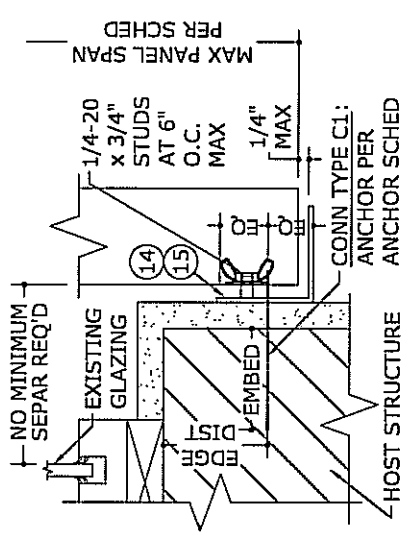

1 MOUNTING SECTION
VERT SECTION
3" = 1'-0"
4

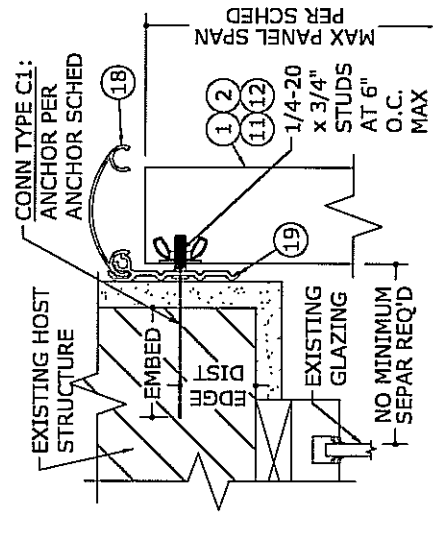

2 MOUNTING SECTION
VERT SECTION
3" = 1'-0"
4

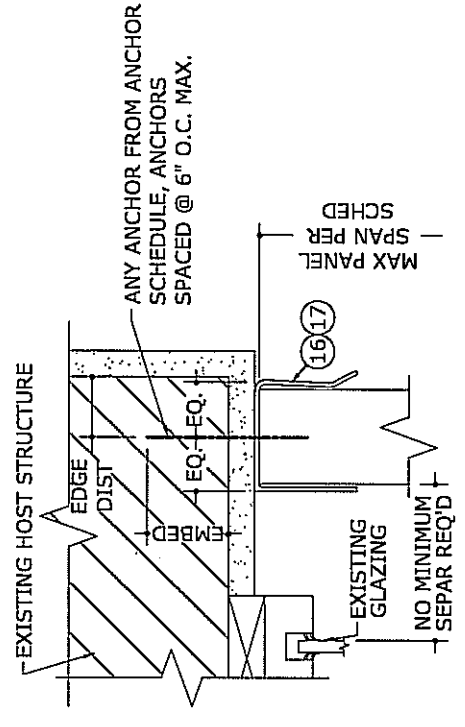

3 MOUNTING SECTION
VERT SECTION
N.T.S.
4

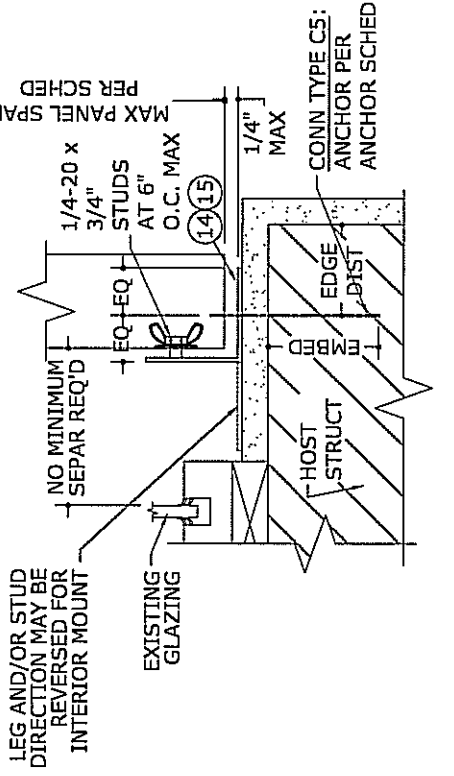

4 MOUNTING SECTION
VERT SECTION
N.T.S.
4

